

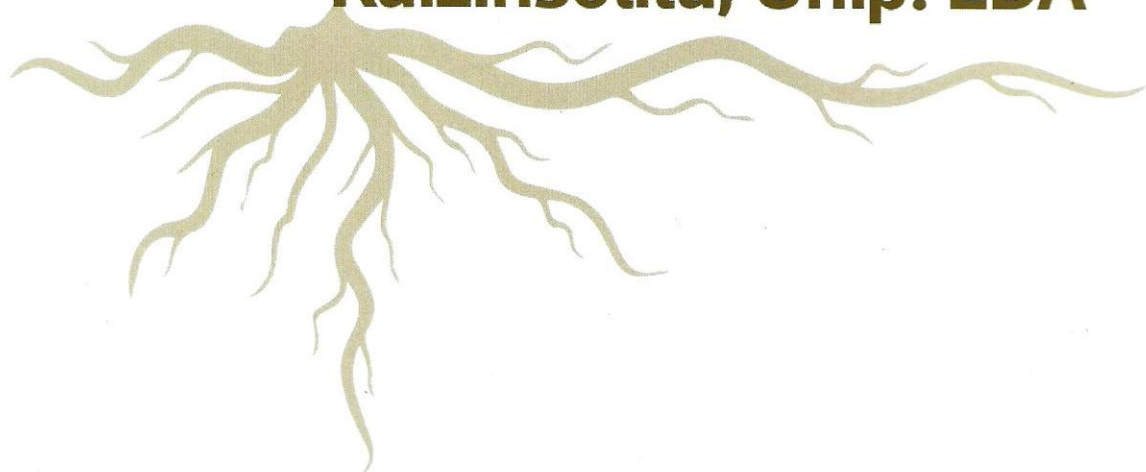

**Raizinsólita, Unip. LDA**



# SEPARADOR

## 1



- LOIÇAS SANITÁRIAS
- URINÓIS
- LAVATÓRIOS CERÂMICOS
- LAVATORIOS SOLID SURFACE
- LAVATÓRIOS INOX
- PIOS VIDRO
- PIOS INOX
- MÓVEIS
- ESPELHOS LED



# LOIÇAS SANITÁRIAS



- SANITA COMPACTA DESCARGA AO CHÃO C/ TAMPO SOFT CLOSE

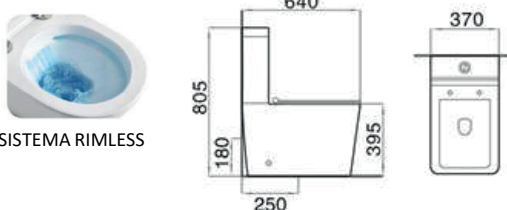

SISTEMA RIMLESS

- BIDÉ DESCARGA AO CHÃO



## ATLANTIS

CÓDIGO €  
15035110 275,00

CÓDIGO €  
15033512 148,00



- SANITA COMPACTA DESCARGA AO CHÃO C/TAMPO SOFT CLOSE

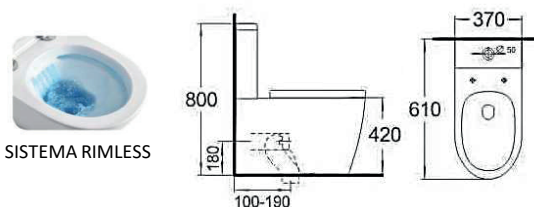

SISTEMA RIMLESS

- BIDÉ DESCARGA AO CHÃO

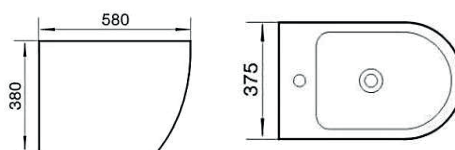

## LIFE

CÓDIGO €  
15025201 275,00

CÓDIGO €  
15025211 148,00



SISTEMA RIMLESS

- SANITA COMPACTA DESCARGA AO CHÃO C/ TAMPO SOFT CLOSE

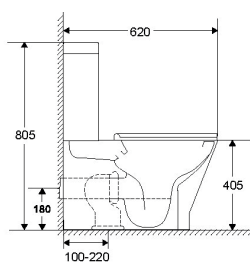

- BIDÉ AO CHÃO



## FEDORA

CÓDIGO €  
15013501 323,00

CÓDIGO €  
15013502 174,00

# LOIÇAS SANITÁRIAS



SISTEMA RIMLESS



- SANITA COMPACTA DESCARGA AO CHÃO C/TAMPO SOFT CLOSE

**PLUMA**

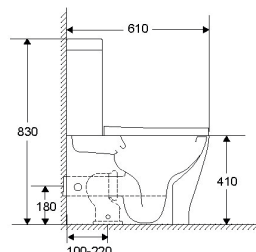

**CÓDIGO €**  
15013401 **323,00**

- BIDÉ DESCARGA AO CHÃO

**CÓDIGO €**  
15013402 **174,00**



- SANITA COMPACTA DESCARGA AO CHÃO C/ TAMPO SOFT CLOSE

**CHARME**



SISTEMA RIMLESS

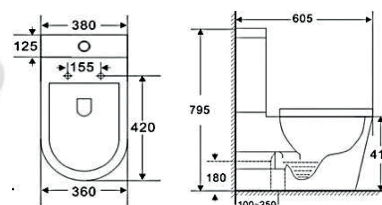

**CÓDIGO €**  
15013271 **237,00**

- BIDÉ DESCARGA AO CHÃO

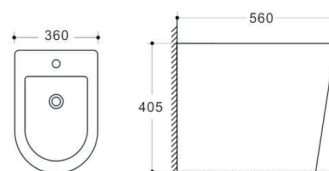

**CÓDIGO €**  
15013272 **135,00**



- SANITA COMPACTA DESCARGA AO CHÃO C/TAMPO SOFT CLOSE

**COZI**



SISTEMA RIMLESS

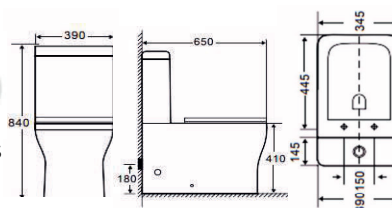

**CÓDIGO €**  
15013231 **276,00**

- BIDÉ DESCARGA AO CHÃO

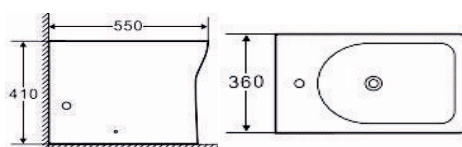

**CÓDIGO €**  
15013233 **168,00**

# LOIÇAS SANITÁRIAS



- SANITA COMPACTA C/DESC. AO CHAO C/TAMPO SOFT CLOSE

**ASTRO**

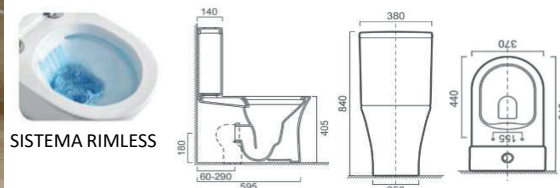

**CÓDIGO** €  
15013261 230,00

- BIDÉ DESCARGA AO CHÃO

**CÓDIGO** €  
15013262 145,00



- SANITA COMPACTA DESCARGA AO CHÃO C/ TAMPO SOFT CLOSE

**GLICINIA**



**CÓDIGO** €  
15013241 192,00

- BIDÉ DESCARGA AO CHÃO

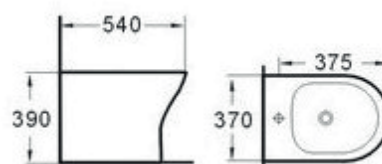

**CÓDIGO** €  
15013243 96,00



- SANITA COMPACTA DESCARGA AO CHÃO C/TAMPO SOFT CLOSE

**COROA**

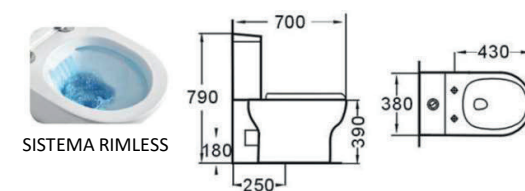

**CÓDIGO** €  
15550101 175,00

- BIDÉ DESCARGA AO CHÃO



**CÓDIGO** €  
15552001 110,00

# LOIÇAS SANITÁRIAS



SISTEMA RIMLESS



- SANITA COMPACTA DESCARGA AO CHÃO C/TAMPO SOFT CLOSE

**ASTER**

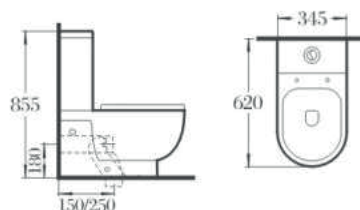

**CÓDIGO** €  
15350201 265,00

- BIDÉ DESCARGA AO CHÃO

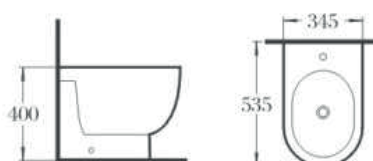

**CÓDIGO** €  
15340210 152,00



- SANITA SUSPENSA C/TAMPO SOFT CLOSE

**DIANA**

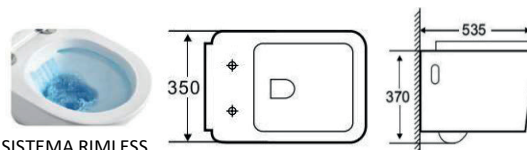

SISTEMA RIMLESS

**CÓDIGO** €  
15523001 170,00

- BIDÉ SUSPENSO

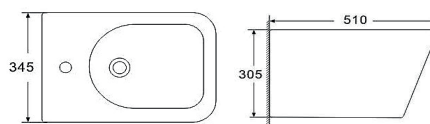

**CÓDIGO** €  
15523011 123,00



SISTEMA RIMLESS

- SANITA SUSPENSA C/TAMPO SOFT CLOSE

**IRIS**

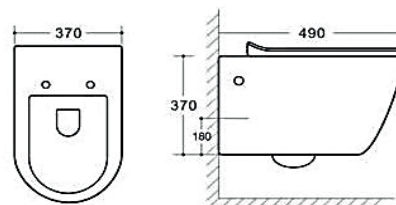

**CÓDIGO** €  
15351001 168,00

IRIS BRANCO MATE  
**CÓDIGO** €  
15351002 320,00

- BIDÉ SUSPENSO

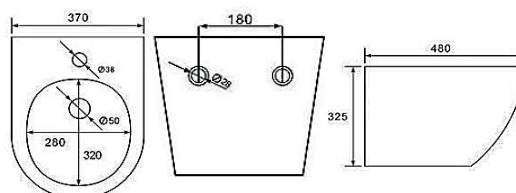

**CÓDIGO** €  
15352001 130,00



# LOIÇAS SANITÁRIAS



- SANITA SUSPENSA C/TAMPO SOFT CLOSE

**LUNA**

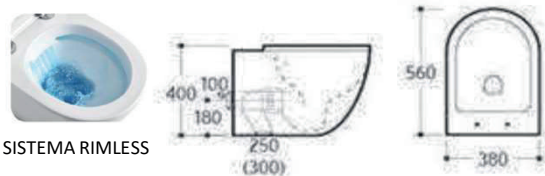

SISTEMA RIMLESS

**CÓDIGO €**  
15025251 170,00

- BIDÉ SUSPENSO

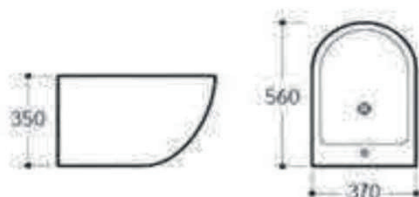

**CÓDIGO €**  
15025261 135,00



- SANITA SUSPENSA C/TAMPO SOFT CLOSE

**CATO**

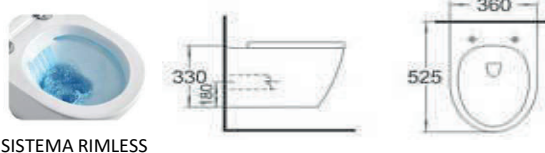

SISTEMA RIMLESS

**CÓDIGO €**  
15075101 175,00

- BIDÉ SUSPENSO



**CÓDIGO €**  
15075111 135,00



SISTEMA RIMLESS

- SANITA SIFONADA DESCARGA AO CHÃO C/ TAMPO SOFT CLOSE

**PALMA SIFÓNICA**

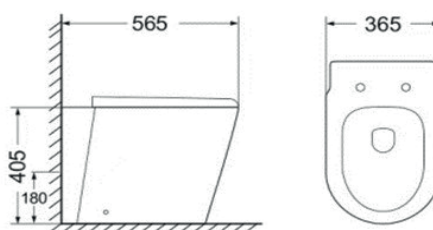

**CÓDIGO €**  
15013228 192,00

# LOIÇAS SANITÁRIAS

## • SANITA SUSPENSA

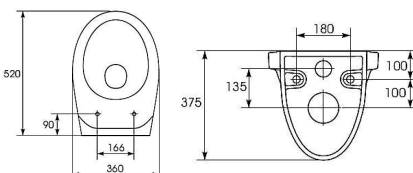

## • BIDE SUSPENSO

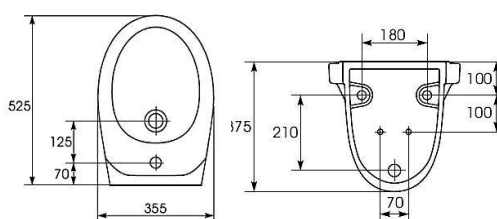

## TERRA

**CÓDIGO** €  
15540101 **144,00**

**Tampo de Sanita**  
**MODELO** €  
A60 **28,00**

**CÓDIGO** €  
15540111 **110,00**

## • SANITA SIMPLES DESCARGA AO CHÃO C/TAMPO

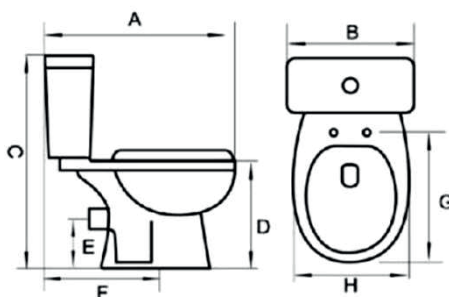

**CÓDIGO** €  
15500101 **99,00**

A: 650mm  
B: 370mm  
C: 760mm  
F: 220mm  
D: 390mm

## • LAVATÓRIO 50 C/COLUNA

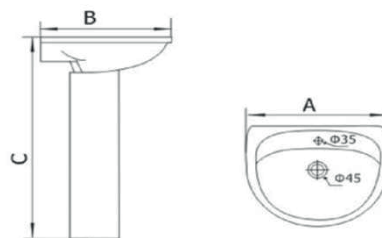

**CÓDIGO** €  
15500401 **52,00**

A: 485mm  
B: 400mm  
C: 888mm

# LOIÇAS SANITÁRIAS



- SANITA SUSPENSA C/TAMPO SOFT CLOSE

**CATO PRETA**  
MATE

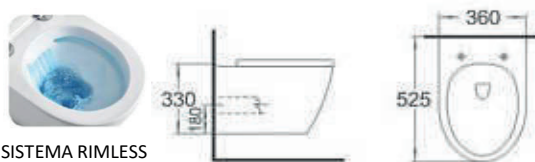

SISTEMA RIMLESS

**CÓDIGO €**  
15075105 **320,00**

- BIDÉ SUSPENSO



**CÓDIGO €**  
15075112 **240,00**



SISTEMA RIMLESS

- SANITA SUSPENSA C/TAMPO SOFT CLOSE

**CATO CINZA**



**CÓDIGO €**  
15075125 **320,00**

- BIDÉ SUSPENSO



**CÓDIGO €**  
15075114 **240,00**



SISTEMA RIMLESS

- SANITA SUSPENSA C/TAMPO SOFT CLOSE

**CATO ANTRACITE**



**CÓDIGO €**  
15075123 **320,00**

- BIDÉ SUSPENSO



**CÓDIGO €**  
15075113 **240,00**

# LOIÇAS SANITÁRIAS



SISTEMA RIMLESS

- SANITA SUSPENSA C/TAMPO SOFT CLOSE

**CATO MOCA**



CÓDIGO	€
15075122	320,00



- BIDÉ SUSPENSO



CÓDIGO	€
15075115	240,00

- SANITA SUSPENSA C/TAMPO SOFT CLOSE

**CATO VERDE**



SISTEMA RIMLESS

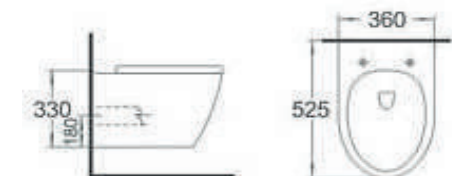

CÓDIGO	€
15075124	320,00

- SANITA SUSPENSA C/TAMPO SOFT CLOSE

**CATO AZUL CLARO**



SISTEMA RIMLESS

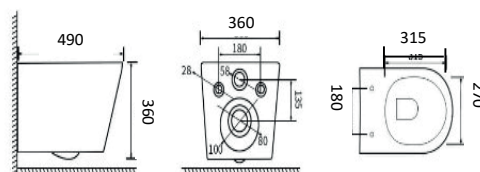

CÓDIGO	€
15075127	320,00

- SANITA SUSPENSA C/TAMPO SOFT CLOSE

**CATO AZUL**



SISTEMA RIMLESS

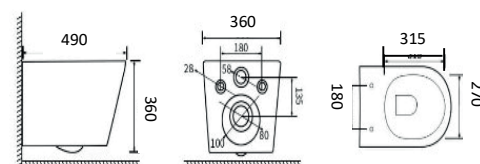

CÓDIGO	€
15075126	320,00

# LOIÇAS SANITÁRIAS



- SANITA SUSPENSA C/TAMPO SOFT CLOSE

**IRIS PRETA**

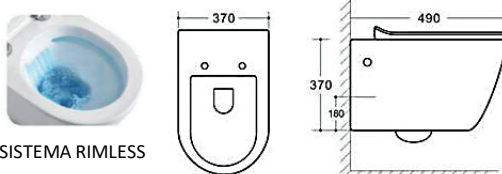

CÓDIGO	€
15351005	320,00

- BIDÉ SUSPENSO

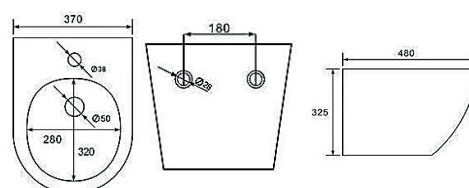

CÓDIGO	€
15351055	240,00



- SANITA SUSPENSA C/TAMPO SOFT CLOSE

**IRIS CINZA**

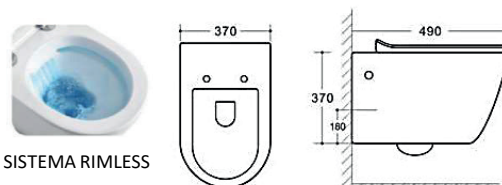

CÓDIGO	€
15351003	320,00

- BIDÉ SUSPENSO

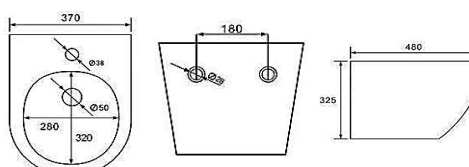

CÓDIGO	€
15351053	240,00



SISTEMA RIMLESS

- SANITA SUSPENSA C/TAMPO SOFT CLOSE

**IRIS ANTRACITE**

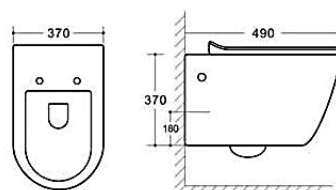

CÓDIGO	€
15351005	320,00

- BIDÉ SUSPENSO

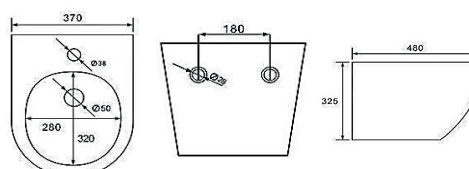

CÓDIGO	€
15351055	240,00

# LOIÇAS SANITÁRIAS



SISTEMA RIMLESS



- SANITA SUSPENSA C/TAMPO SOFT CLOSE

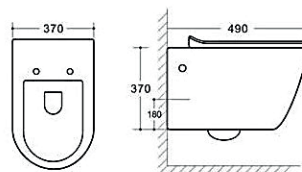

## IRIS MOCA

**CÓDIGO** €  
15351006 320,00

- BIDÉ SUSPENSO

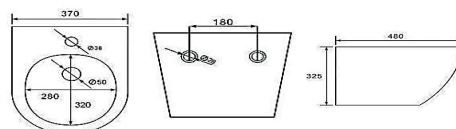

**CÓDIGO** €  
15351056 240,00



SISTEMA RIMLESS

- SANITA SUSPENSA C/TAMPO SOFT CLOSE

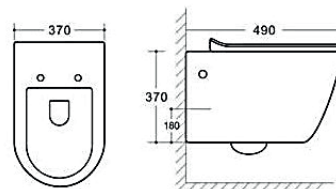

## IRIS VERDE

**CÓDIGO** €  
15351007 320,00



SISTEMA RIMLESS

- SANITA SUSPENSA C/TAMPO SOFT CLOSE

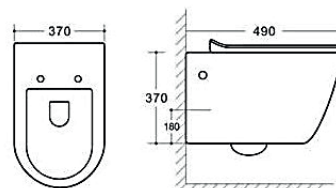

## IRIS AZUL

**CÓDIGO** €  
15351008 320,00



- SANITA COMPACTA DESCARGA AO CHÃO C/ TAMPO SOFT CLOSE

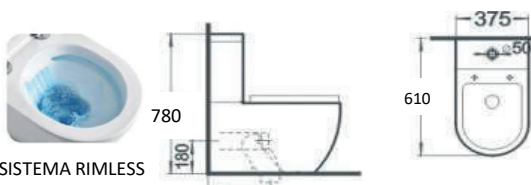

SISTEMA RIMLESS

## PALMA PRETA MATE

**CÓDIGO** €  
15013222 490,00

- BIDÉ DESCARGA AO CHÃO

**CÓDIGO** €  
15013224 260,00

## LOIÇAS MOBILIDADE REDUZIDA



deca

### P51

SANITA SIMPLES DESCARGA AO CHÃO

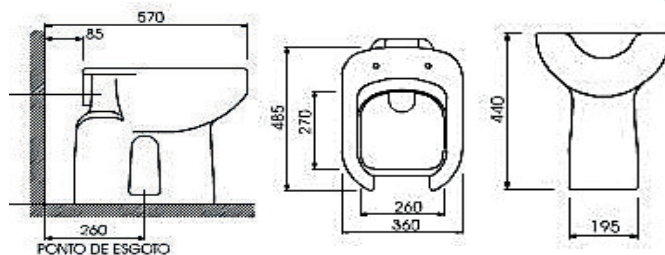

CÓDIGO	MEDIDAS	€
15250111	440x360x485	180,00

### AP52

TAMPO DE SANITA

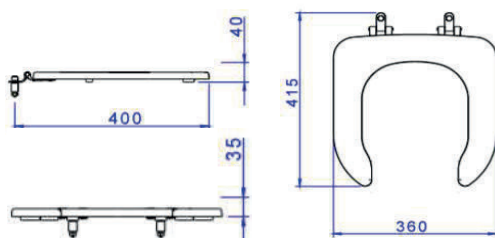

CÓDIGO	MATERIAL	€
19070901	POLIESTER	130,00
19070911	MDF	60,00

### VOGUE PLUS L51

LAVATÓRIO

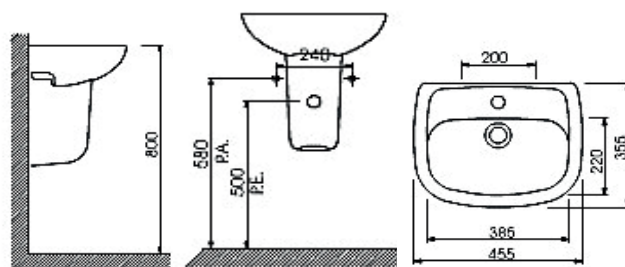

CÓDIGO	MEDIDAS	€
15250311	440x360x535	113,00

COLUNA SUSPENSA CS1

CÓDIGO	MEDIDAS	€
15250315	-	72,00

### PMR C/ ABERTURA

SANITA COMPACTA COMPLETA DESCARGA AO CHÃO

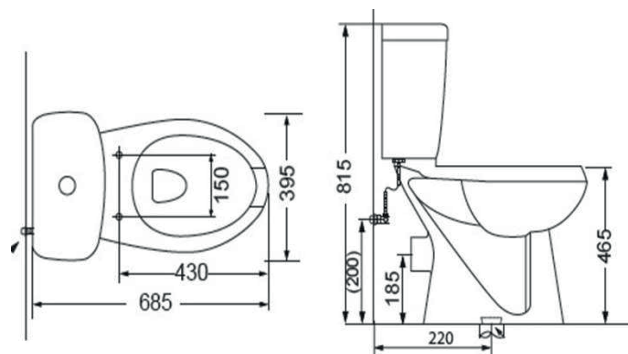

CÓDIGO	MEDIDAS	€
15250115	395x680x465	341,00

## LOIÇAS MOBILIDADE REDUZIDA



### PMR FHK

LAVATÓRIO SUSPENSO

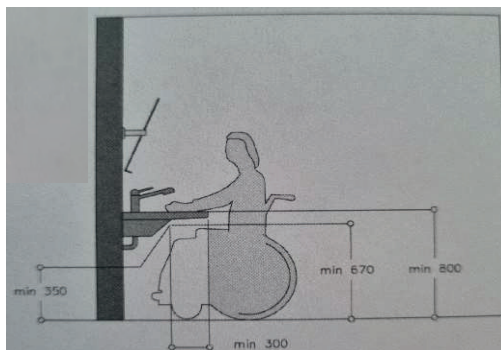

CÓDIGO	MEDIDAS	€
15250306	650x545x200	210,00

- Kit parafuso fixação incluído
- Altura mínima para instalação do lavatório 800mm

### PMR S/ ABERTURA

SANITA COMPACTA COMPLETA DESCARGA AO CHÃO

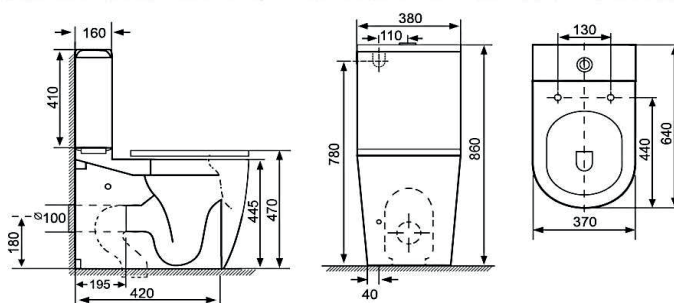

CÓDIGO	MEDIDAS	€
15250114	370x640x860	336,00

# URINOIS

deca

## SAVE M719

URINOL FIXAR À PAREDE S/ ÁGUA

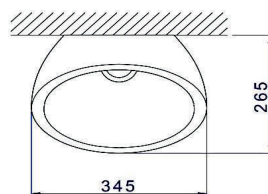

CÓDIGO	MEDIDAS	€
12100150	510X320X245	332,00

VALVULA DESODORIZADORA P/ URINOL

CÓDIGO	MEDIDAS	€
12100145	-	110,00



Não necessita de água

## SAVE M718

URINOL FIXAR À PAREDE S/ ÁGUA

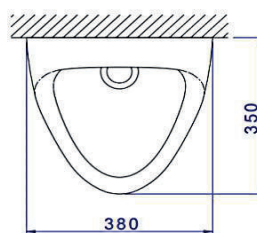
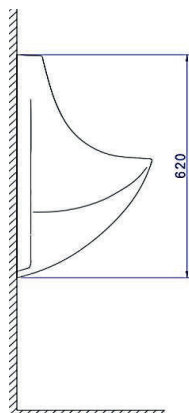

CÓDIGO	MEDIDAS	€
12100140	620X380X350	342,00

VALVULA DESODORIZADORA P/ URINOL

CÓDIGO	MEDIDAS	€
12100145	-	110,00



Não necessita de água

## FHK8848

URINOL FIXAR À PAREDE



CÓDIGO	MEDIDAS	€
12100116	550X340	96,00

# URINOIS

## AMG514

URINOL FIXAR À PAREDE

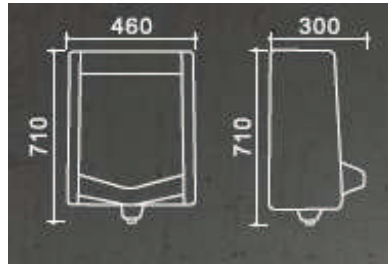

CÓDIGO	MEDIDAS	€
12100106	550X320X350	78,00

## AMG194

URINOL FIXAR À PAREDE

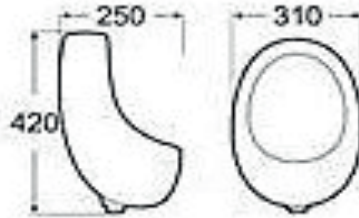

CÓDIGO	MEDIDAS	€
12100104	420x310x250	90,00

## AMG1650

URINOL FIXAR À PAREDE

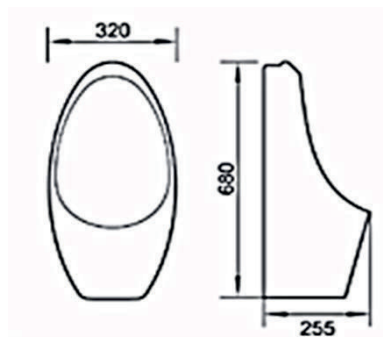

CÓDIGO	MEDIDAS	€
12100103	680x320x255	96,00

# LAVATÓRIOS COLUNA CERÂMICOS

## LOTUS S/ FURO

LAVATÓRIO S/ FURO P/ TORNEIRA

BRANCO



CÓDIGO	MEDIDAS	€
15013102	810x500x385	450,00

## LOTUS C/ FURO

LAVATÓRIO C/ FURO P/ TORNEIRA

BRANCO



CÓDIGO	MEDIDAS	€
15013101	830x500	450,00

## LOTUS PRETO

LAVATÓRIO C/ FURO P/ TORNEIRA

PRETO MATE



CÓDIGO	MEDIDAS	€
15013103	830x500	550,00

## LOTUS MB

LAVATÓRIO C/ FURO P/ TORNEIRA

MARMORE



CÓDIGO	MEDIDAS	€
12011520	840x500	550,00

## LAVATÓRIOS COLUNA CERÂMICOS

### GAMMA PRETO

LAVATÓRIO C/ FURO P/ TORNEIRA

PRETO



CÓDIGO	MEDIDAS	€
12011502	875x450	550,00

### GAMMA

LAVATÓRIO C/ FURO P/ TORNEIRA

BRANCO



CÓDIGO	MEDIDAS	€
12011501	875x500	450,00

### COLISEU MB Marmore Cinza

LAVATÓRIO C/ FURO P/ TORNEIRA

CINZA



CÓDIGO	MEDIDAS	€
12011551	880x880x450	690,00

### COLISEU MB Marmore Castanho

LAVATÓRIO C/ FURO P/ TORNEIRA

CASTANHO



CÓDIGO	MEDIDAS	€
12011552	880x880x450	690,00

## LAVATÓRIOS COLUNA CERÂMICOS

### COLISEU BRANCO

LAVATÓRIO S/ FURO P/ TORNEIRA

BRANCO



CÓDIGO	MEDIDAS	€
12011511	880x450	450,00

### COLISEU BRANCO

LAVATÓRIO C/ FURO P/ TORNEIRA

BRANCO



CÓDIGO	MEDIDAS	€
12011508	880x450	450,00

### COLISEU PRETO

LAVATÓRIO S/ FURO P/ TORNEIRA

PRETO



CÓDIGO	MEDIDAS	€
12011513	850x850x450	550,00

### COLISEU PRETO

LAVATÓRIO C/ FURO P/ TORNEIRA

PRETO



CÓDIGO	MEDIDAS	€
12011514	880x450x450	550,00

## LAVATÓRIOS COLUNA CERÂMICOS

### GLOBO

LAVATÓRIO C/ FURO P/ TORNEIRA

BRANCO



CÓDIGO

12011541

MEDIDAS

860x420

€

425,00

### GLOBO

LAVATÓRIO S/ FURO P/ TORNEIRA

BRANCO



CÓDIGO

12011541

MEDIDAS

860x420

€

425,00

### TRIUNFO

LAVATÓRIO C/ FURO P/ TORNEIRA

BRANCO



CÓDIGO

12011507

MEDIDAS

850x450

€

450,00

### TRIUNFO

LAVATÓRIO S/ FURO P/ TORNEIRA

BRANCO



CÓDIGO

12011504

MEDIDAS

850x450

€

450,00

## LAVATÓRIOS COLUNA CERÂMICOS

### TRIUNFO

LAVATÓRIO S/ FURO P/ TORNEIRA

MARMORE



CÓDIGO

12011510

MEDIDAS

850x450

€

550,00

### CONE MARMORE

LAVATÓRIO C/ FURO P/ TORNEIRA

MARMORE CREME



CÓDIGO

12011524

MEDIDAS

820x445

€

550,00

### CONE PRETO

LAVATÓRIO S/ FURO P/ TORNEIRA

PRETO



CÓDIGO

12011532

MEDIDAS

850x400

€

550,00

### CONE BRANCO

LAVATÓRIO S/ FURO P/ TORNEIRA

BRANCO



CÓDIGO

15011531

MEDIDAS

850x400

€

450,00

## LAVATÓRIOS COLUNA CERÂMICOS

### CONE DOURADO

LAVATÓRIO S/ FURO P/ TORNEIRA

OURO MATE



CÓDIGO

12011534

MEDIDAS

850x400

€

590,00

### CONE DOURADO

LAVATÓRIO C/ FURO P/ TORNEIRA

OURO MATE



CÓDIGO

12011536

MEDIDAS

410x850

€

590,00

### CONE MARMORE

LAVATÓRIO C/ FURO P/ TORNEIRA

MARMORE PRETO



CÓDIGO

12011523

MEDIDAS

820x445

€

550,00

### TOPÁZIO BRANCO

LAVATÓRIO S/ FURO P/ TORNEIRA

BRANCO

PEDRA ARTIFICIAL



CÓDIGO

12011751

MEDIDAS

450x450x860

€

865,00

## LAVATÓRIOS COLUNA PEDRA ARTIFICIAL

### TOPÁZIO CINZA

LAVATÓRIO S/ FURO P/ TORNEIRA

CINZA



CÓDIGO	MEDIDAS	€
12011755	450x450x860	865,00

### TOPÁZIO COR OURO/PRETO

LAVATÓRIO S/ FURO P/ TORNEIRA

OURO/PRETO



CÓDIGO	MEDIDAS	€
12011758	450x450x860	950,00

### JADE BRANCO

LAVATÓRIO S/ FURO P/ TORNEIRA

BRANCO



CÓDIGO	MEDIDAS	€
12011701	450x860	865,00

### JADE CINZA

LAVATÓRIO S/ FURO P/ TORNEIRA

CINZA



CÓDIGO	MEDIDAS	€
12011705	450x860	865,00

# LAVATÓRIOS CERÂMICOS



**L73.95**

LAVATÓRIO POUJAR

PRETO



CÓDIGO	MEDIDAS	€
12011091	410x410x155	188,00

**L70.95**

LAVATÓRIO POUJAR

PRETO



CÓDIGO	MEDIDAS	€
12011066	410x410x155	192,00

**L107.95**

LAVATÓRIO POUJAR

PRETO



CÓDIGO	MEDIDAS	€
12011261	560x275x135	185,00

**L93.95**

LAVATÓRIO POUJAR

PRETO



CÓDIGO	MEDIDAS	€
12011157	Ø 500x410x130	254,00

**L89.95**

LAVATÓRIO POUJAR

PRETO



CÓDIGO	MEDIDAS	€
12011056	760x460x115	430,00

# LAVATÓRIOS CERÂMICOS



## L59.17

LAVATÓRIO ENCASTRAR P/ BAIXO BRANCO



CÓDIGO	MEDIDAS	€
12011321	400x300x150	57,00

## L1030.17

LAVATÓRIO ENCASTRAR P/ BAIXO BRANCO



CÓDIGO	MEDIDAS	€
12011033	315x315x145	54,00

## L701.17

LAVATÓRIO ENCASTRAR P/ BAIXO BRANCO



CÓDIGO	MEDIDAS	€
12011241	410x410x180	148,00

## L1071.17

LAVATÓRIO ENCASTRAR P/ BAIXO BRANCO



CÓDIGO	MEDIDAS	€
12011251	590x305x135	176,00

## L41.17

LAVATÓRIO ENCASTRAR P/ BAIXO BRANCO



CÓDIGO	MEDIDAS	€
12011006	Ø 350x145	52,00

## L64.17

LAVATÓRIO ENCASTRAR P/ CIMA BRANCO



CÓDIGO	MEDIDAS	€
12011041	565x435x130	122,00

# LAVATÓRIOS CERÂMICOS

deca

## L1070.17

LAVATÓRIO ENCASTRAR P/ CIMA BRANCO



CÓDIGO	MEDIDAS	€
12011246	590x305x135	176,00

## L840.17

LAVATÓRIO ENCASTRAR P/ CIMA BRANCO



CÓDIGO	MEDIDAS	€
12011341	540x430x165	184,00

## L55.17

LAVATÓRIO POUSAR BRANCO



CÓDIGO	MEDIDAS	€
12011021	Ø 400x150	115,00

## L68.17

LAVATÓRIO POUSAR BRANCO



CÓDIGO	MEDIDAS	€
12011051	500x370x140	120,00

## LC26.17

LAVATÓRIO QUADRADO C/ COLUNA BRANCO



CÓDIGO	MEDIDAS	€
12011271	850x400x400	750,00

## L69.17

LAVATÓRIO SUSPENSO BRANCO



CÓDIGO	COMPLEMENTO	€
12011297	-	152,00
12011279	semi coluna C69	72,00

MED. 500x300x140

# LAVATÓRIOS CERÂMICOS



## L70.17

LAVATÓRIO POUSAR

BRANCO



CÓDIGO	MEDIDAS	€
12011061	410x410x155	160,00

## L71.17

LAVATÓRIO POUSAR

BRANCO



CÓDIGO	MEDIDAS	€
12011071	Ø 400x145	152,00

## L73.17

LAVATÓRIO POUSAR

BRANCO



CÓDIGO	MEDIDAS	€
12011081	410x410x155	156,00

## U7301

LAVATÓRIO POUSAR

BRANCO



CÓDIGO	MEDIDAS	€
12011371	350x315x110	136,00

## L1036.17

LAVATÓRIO POUSAR

BRANCO



CÓDIGO	MEDIDAS	€
12011366	Ø 390x190x100	155,00

## L80C.17

LAV. SEMI ENCAIXE C/ TOALHEIRO

BRANCO



MEDIDAS: 410x410x155

CÓDIGO	COMPLEMENTO	€
12011096	C/ TOALHEIRO	242,00

# LAVATÓRIOS CERÂMICOS



## L83C.17

LAVAT. SEMI ENCAIXE C/ TOALHEIRO BRANCO



MEDIDAS: 410x410x155

CÓDIGO	COMPLEMENTO	€
12011101	C/ TOALHEIRO	316,00

## L87.17

LAVATÓRIO POUSAR C/ VALV OCULTA BRANCO

\* VALVULA INCLUÍDA

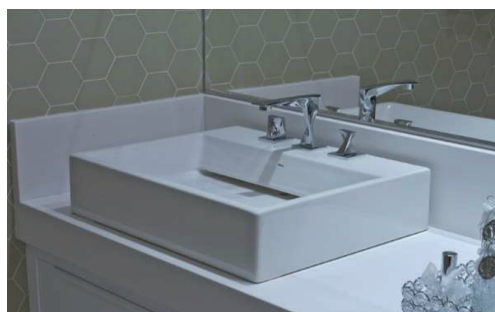

MEDIDAS: 560x460x135

CÓDIGO	COMPLEMENTO	€
12011311	POUSAR	355,00
12011300	SUSPENSO	398,00

## L89.17

LAVATÓRIO POUSAR C/ VALV OCULTA BRANCO

\* VALVULA INCLUÍDA

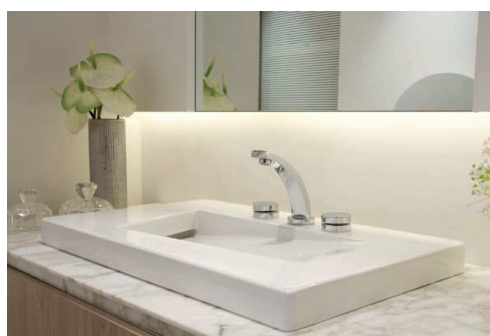

CÓDIGO	MEDIDAS	€
12011055	760x460x115	398,00

## L86.17

LAVATÓRIO POUSAR C/ VALV OCULTA BRANCO

\* VALVULA INCLUÍDA



MEDIDAS: 460x460x135

CÓDIGO	COMPLEMENTO	€
12011106	POUSAR	310,00
12011306	SUSPENSO	344,00

## L88.17

LAVATÓRIO POUSAR C/ VALV OCULTA BRANCO

\* VALVULA INCLUÍDA



MEDIDAS: 760x460x135

CÓDIGO	COMPLEMENTO	€
12011136	POUSAR	398,00
12011291	SUSPENSO	455,00

## L90.17

LAVATÓRIO POUSAR E SOBREPOR BRANCO

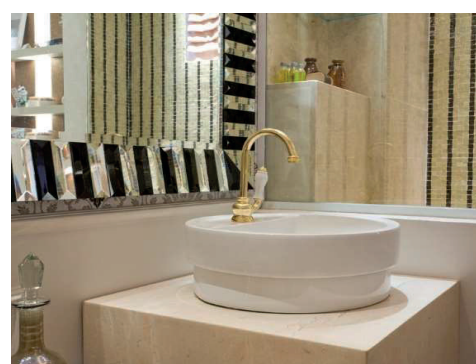

CÓDIGO	MEDIDAS	€
12011146	Ø 455x160x85	195,00

# LAVATÓRIOS CERÂMICOS



## L93.17

LAVATÓRIO POUSAR

BRANCO



CÓDIGO	MEDIDAS	€
12011156	Ø 500x410x130	208,00

## L95.17

LAVATÓRIO POUSAR

BRANCO



MEDIDAS: 920x460x165

CÓDIGO		€
12011171	POUSAR	398,00
12011175	SUSPENSO	420,00

## L102.17

LAVATÓRIO POUSAR

BRANCO

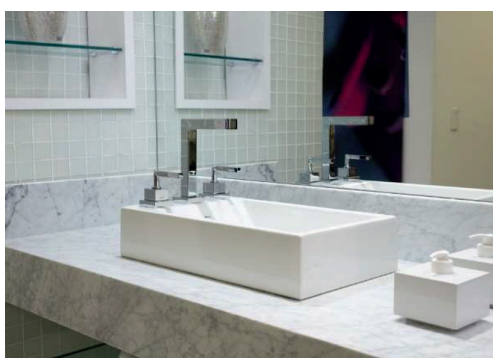

CÓDIGO	MEDIDAS	€
12011201	510x310x120	232,00

## L106.17

LAVATÓRIO POUSAR

BRANCO



CÓDIGO	MEDIDAS	€
12011221	550x270x135	178,00

## L107.17

LAVATÓRIO POUSAR

BRANCO



CÓDIGO	MEDIDAS	€
12011226	560x275x135	149,00

## L108.17

LAVATÓRIO POUSAR

BRANCO



CÓDIGO	MEDIDAS	€
12011165	350x350x110	180,00

# LAVATÓRIOS CERÂMICOS



## L155.17

LAVATÓRIO POUSAR

BRANCO



CÓDIGO	MEDIDAS	€
12011027	Ø 350x125	148,00

## L125.17

LAVATÓRIO POUSAR

BRANCO



CÓDIGO	MEDIDAS	€
12011361	580x400x135	198,00

## L126.17

LAVATÓRIO POUSAR

BRANCO



CÓDIGO	MEDIDAS	€
12011195	Ø 375x90	196,00

## LL19.17

LAVATÓRIO POUSAR

BRANCO



MEDIDAS: 600x450x100

CÓDIGO		€
12011381	POUSAR	256,00
12011382	SUSPENSO	268,00

## L1034.17

LAVATÓRIO POUSAR

BRANCO



CÓDIGO	MEDIDAS	€
12011385	750x420x130	220,00

## L1035.17

LAVATÓRIO POUSAR

BRANCO



CÓDIGO	MEDIDAS	€
12011391	640x425x130	224,00

# LAVATÓRIOS CERÂMICOS



## L1037.17

LAVATÓRIO POU SAR

BRANCO



CÓDIGO	MEDIDAS	€
12011395	400x400x130	172,00

## L1038.17

LAVATÓRIO POU SAR

BRANCO



CÓDIGO	MEDIDAS	€
12011401	595x455x130	232,00

## L1039.17

LAVATÓRIO POU SAR

BRANCO



CÓDIGO	MEDIDAS	€
12011435	465x465x135	185,00

## L1044C.17

LAVAT. POU SAR E SOBREPOR

BRANCO

*\*saboneteira incluída*

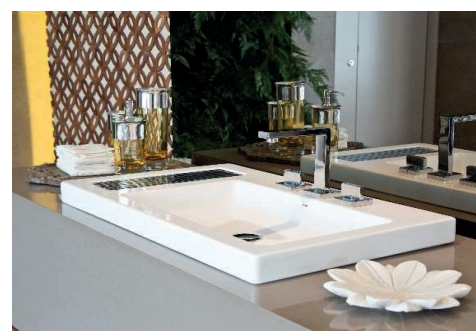

CÓDIGO	MEDIDAS	€
12011415	800x475x95	644,00

## L152C.17

LAVATÓRIO DUPLO SOBREPOR

BRANCO



CÓDIGO	MEDIDAS	€
12011470	1200x550x165	1 460,00

## L140.17

LAVATÓRIO POU SAR

BRANCO



CÓDIGO	MEDIDAS	€
12011466	1400x550x155	1 457,00

# LAVATÓRIOS CERÂMICOS



## L270.17

LAVATÓRIO POUSAR

BRANCO



CÓDIGO	MEDIDAS	€
12011345	420x420x130	204,00

## L863.17

LAV. SEMI ENCAIXE C/ VALV. OCULTA

BRANCO

\* VALVULA INCLUÍDA

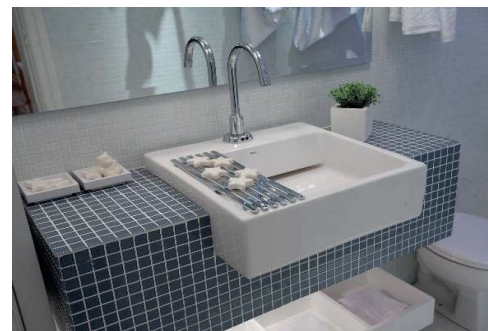

CÓDIGO	MEDIDAS	€
12011116	460x460x135	298,00

## L873.17

SEMI ENCAIXE C/ VALV. OCULTA

BRANCO

\* VALVULA INCLUIDA



CÓDIGO	MEDIDAS	€
12011131	560x460x135	356,00

## L904.17

LAVATÓRIO POUSAR

BRANCO



CÓDIGO	MEDIDAS	€
12011481	Ø 450x100	198,00

## L101.17

LAVATÓRIO CANTO SUSPENSO

BRANCO



CÓDIGO	MEDIDAS	€
12011283	410x330x150	48,00

## L15.17 Izy

LAVATÓRIO SUSPENSO

BRANCO



CÓDIGO	MEDIDAS	€
12011284	395x295	38,00

# LAVATÓRIOS CERÂMICOS



## SL01.17

SUPORTE SUSPENSO P/ LAVATORIC BRANCO  
LAVATORIOS: L55, L68, L70, L92, L93 E L70



CÓDIGO	MEDIDAS	€
12011386	450x300x500	290,00

## E79C.17

SABONETEIRA COM TOALHEIRO BRANCO



CÓDIGO	MEDIDAS	€
05035241	300x100x50	145,00

## L116D.17

TANQUE MULTIUSO COM DECK BRANCO



CÓDIGO	MEDIDAS	€
12011294	565x355x400	854,00

# LAVATÓRIOS CERÂMICOS

## AMB084

LAVATÓRIO POUSAR

BRANCO



CÓDIGO	MEDIDAS	€
12010131	510x450x150	94,00

## AMB0684

LAVATÓRIO POUSAR

BRANCO



CÓDIGO	MEDIDAS	€
12010202	460x460x160	98,00

## H-8040

LAVATÓRIO POUSAR

BRANCO



CÓDIGO	MEDIDAS	€
12010161	400x400x140	82,00

## AMC4148

LAVATÓRIO POUSAR

BRANCO



CÓDIGO	MEDIDAS	€
12010102	400x400x140	71,00

## H-430

LAVATÓRIO POUSAR

BRANCO



CÓDIGO	MEDIDAS	€
12010160	560x360x120	94,00

## H-8041

LAVATÓRIO POUSAR

BRANCO



CÓDIGO	MEDIDAS	€
12010247	510x400x140	113,00

# LAVATÓRIOS CERÂMICOS

## H-8065

LAVATÓRIO POUSAR

BRANCO



CÓDIGO	MEDIDAS	€
12010248	650x450x110	130,00

## H-8065-75

LAVATÓRIO POUSAR

BRANCO



CÓDIGO	MEDIDAS	€
12010287	750x450x130	180,00

## H-1276

LAVATÓRIO POUSAR

BRANCO



CÓDIGO	MEDIDAS	€
12010250	600x420x130	147,00

## H-8058

LAVATÓRIO POUSAR

BRANCO



CÓDIGO	MEDIDAS	€
12010251	805x405x135	210,00

## H-425

LAVATÓRIO POUSAR

BRANCO



CÓDIGO	MEDIDAS	€
12010404	450x305x105	65,00

## H-8036

LAVATÓRIO POUSAR

BRANCO



CÓDIGO	MEDIDAS	€
12010405	505x380x120	103,00

# LAVATÓRIOS CERÂMICOS

## H-8033

LAVATÓRIO POUSAR

BRANCO



CÓDIGO	MEDIDAS	€
12010142	520x420x155	125,00

## EZ477

LAVATÓRIO POUSAR

BRANCO



CÓDIGO	MEDIDAS	€
12010144	500x430x140	108,00

## DH-533

LAVATÓRIO POUSAR

BRANCO



CÓDIGO	MEDIDAS	€
12010403	480x340x150	89,00

## 4104

LAVATÓRIO POUSAR

BRANCO



CÓDIGO	MEDIDAS	€
12010143	Ø 380	89,00

## JOY BRANCO

LAVATÓRIO POUSAR

BRANCO



MEDIDA: Ø 420

CÓDIGO	ACABAMENTO	€
12010305	BRILHO	125,00
12010306	MATE	173,00

## HY-5089

LAVATÓRIO POUSAR

BRANCO



CÓDIGO	MEDIDAS	€
12010406	470x140	90,00

# LAVATÓRIOS CERÂMICOS

## FK-8030-50

LAVATÓRIO POUSAR

BRANCO



CÓDIGO	MEDIDAS	€
12010206	505x340x110	115,00

## FK-8030-60

LAVATÓRIO POUSAR

BRANCO



CÓDIGO	MEDIDAS	€
12010283	605x340x110	120,00

## FK-8030-65

LAVATÓRIO POUSAR

BRANCO



CÓDIGO	MEDIDAS	€
12010274	650x340x110	136,00

## H-8064-45

LAVATÓRIO POUSAR

BRANCO



CÓDIGO	MEDIDAS	€
12010255	450x380x110	113,00

## H-8064-55

LAVATÓRIO POUSAR

BRANCO



CÓDIGO	MEDIDAS	€
12010254	550x380x110	115,00

## H-8064-65

LAVATÓRIO POUSAR

BRANCO



CÓDIGO	MEDIDAS	€
12010256	650x380x110	136,00

# LAVATÓRIOS CERÂMICOS

## H-8074

LAVATÓRIO POUSAR

BRANCO



CÓDIGO	MEDIDAS	€
12010257	430x430x150	91,00

## H-8067

LAVATÓRIO POUSAR

BRANCO



CÓDIGO	MEDIDAS	€
12010321	480x295x125	86,00

## H-8018

LAVATÓRIO POUSAR

BRANCO



CÓDIGO	MEDIDAS	€
12010298	460x320x135	72,00
12010259	485x395x145	91,00

## HA-461

LAVATÓRIO POUSAR

BRANCO



CÓDIGO	MEDIDAS	€
12010266	510x340x135	86,00

## FK8056

LAVATÓRIO POUSAR

BRANCO



CÓDIGO	MEDIDAS	€
12010210	610x415x135	120,00

## H-8057

LAVATÓRIO POUSAR

BRANCO



CÓDIGO	MEDIDAS	€
12010279	805x405x135	140,00

# LAVATÓRIOS CERÂMICOS

## H-8015

LAVATÓRIO POUSAR

BRANCO



MEDIDA: 490x355x130

CÓDIGO	ACABAMENTO	€
12010288	BRILHO	98,00
12010308	MATE	140,00

## A-423

LAVATÓRIO POUSAR

BRANCO



MEDIDA: 385x385x140

CÓDIGO	ACABAMENTO	€
12010260	BRILHO	91,00
12010261	MATE	130,00

## WT-41280

LAVATÓRIO POUSAR

BRANCO



CÓDIGO	MEDIDAS	€
12010193	680x415x115	120,00

## K435

LAVATÓRIO POUSAR

BRANCO



CÓDIGO	MEDIDAS	€
12010407	500x390x145	120,00

## H-8055

LAVATÓRIO POUSAR

BRANCO



CÓDIGO	MEDIDAS	€
12010302	400x355x130	82,00

## WT-41266

LAVATÓRIO POUSAR

BRANCO



CÓDIGO	MEDIDAS	€
12010192	600x400x135	120,00

# LAVATÓRIOS CERÂMICOS

## H-A022

LAVATÓRIO POUSAR

BRANCO



CÓDIGO	MEDIDAS	€
12010297	480x370x130	74,00
12010263	BR. MATE	120,00

## H-A545

LAVATÓRIO POUSAR

BRANCO



CÓDIGO	MEDIDAS	€
12010267	400x125	140,00

## H-A524

LAVATÓRIO POUSAR

BRANCO



CÓDIGO	MEDIDAS	€
12010270	Ø 430x150	140,00

## H-8021

LAVATÓRIO POUSAR

BRANCO



CÓDIGO	MEDIDAS	€
12010258	Ø 415x135	82,00

## FK-8070

LAVATÓRIO POUSAR

BRANCO



MEDIDA: Ø 360x115

CÓDIGO	ACAB.	€
12010212	BR. BRILHO	74,00
12010249	BR. MATE	115,00

## WT-8040

LAVATÓRIO POUSAR

BRANCO



CÓDIGO	MEDIDAS	€
12010408	Ø 40	90,00

# LAVATÓRIOS CERÂMICOS

## C350

LAVATÓRIO POUSAR

BRANCO



CÓDIGO	MEDIDA	€
12010299	Ø 320x145	78,00
12010253	Ø 410x145	82,00

## AMM2163

LAVATÓRIO SUSPENSO

BRANCO



CÓDIGO	MEDIDAS	€
15500421	415x320x190	35,00

## WT012

LAVATÓRIO ENCASTRAR P/ BAIXO

BRANCO



CÓDIGO	MEDIDAS	€
12010341	465x380	62,00

## HK-0533

LAVATÓRIO ENCASTRAR P/ BAIXO

BRANCO



CÓDIGO	MEDIDAS	€
12010703	495x415x195	42,00

## FK3028

LAVATÓRIO ENCASTRAR P/ BAIXO

BRANCO



CÓDIGO	MEDIDAS	€
12010245	525x340x175	58,00

## HK-0528

LAVATÓRIO ENCASTRAR P/ BAIXO

BRANCO



CÓDIGO	MEDIDAS	€
12010704	465x350x200	58,00

# LAVATÓRIOS CERÂMICOS

## PLANO

LAVATÓRIO TIPO BANCADA SOBREPOR



CÓDIGO	MED.	€
12010519	51x46	<b>70,00</b>
12010521	61x46	<b>70,00</b>
12010530	71x46	<b>72,00</b>
12010535	81x46	<b>74,00</b>
12010551	101x46	<b>106,00</b>
12010561	121x46	<b>162,00</b>

## PLANO DRT

LAVATÓRIO TIPO BANCADA SOBREPOR



CÓDIGO	MED.	€
12010583	81x46	<b>149,00</b>
12010585	101x46	<b>187,00</b>
12010587	121x46	<b>237,00</b>

## PLANO ESQ

LAVATÓRIO TIPO BANCADA SOBREPOR



CÓDIGO	MED.	€
12010573	81x46	<b>149,00</b>
12010575	101x46	<b>187,00</b>
12010577	121x46	<b>237,00</b>

## PLANO DUPLO

LAVATÓRIO DUPLO TIPO BANCADA SOBREPOR



CÓDIGO	MED	€
12010562	120x46	<b>190,00</b>
12010565	150x46	<b>650,00</b>

## LAVATÓRIOS CERÂMICOS

### FK8058

LAVATÓRIO POUSAR

PRETO



CÓDIGO	MEDIDAS	€
12010214	805x405x135	280,00

### H-8057 BLACK

LAVATÓRIO POUSAR

PRETO



CÓDIGO	MEDIDAS	€
12010271	805x405x135	280,00

### H-8064 BLACK

LAVATÓRIO POUSAR

PRETO



CÓDIGO	MEDIDAS	€
12010414	740x380x130	220,00

### FK-8030-50 PRETO MATE

LAVATÓRIO POUSAR

PRETO MATE



CÓDIGO	MEDIDAS	€
12010310	505x340x110	140,00
12010311	605x340x110	160,00

### A423 MARMORE PRETO

LAVATÓRIO POUSAR

MARMORE PRETO



CÓDIGO	MEDIDAS	€
12010262	400x400x145	138,00

### A423 BLACK

LAVATÓRIO POUSAR

PRETO



medidas: 385x385x140

CÓDIGO	ACABAMENTO	€
12010234	BRILHO	114,00
12010277	MATE	140,00

# LAVATÓRIOS CERÂMICOS

## A-524 BLACK

LAVATÓRIO POUSAR

PRETO MATE



CÓDIGO	MEDIDAS	€
12010246	360x360x115	114,00

## H-8079 BLACK

LAVATÓRIO POUSAR

PRETO



CÓDIGO	MEDIDAS	€
12010281	675x390x120	262,00

## H-8078 BLACK

LAVATÓRIO POUSAR

PRETO



CÓDIGO	MEDIDAS	€
12010216	390x390x150	193,00

## H-8077 BLACK

LAVATÓRIO POUSAR

PRETO



CÓDIGO	MEDIDAS	€
12010316	Ø 400x180	193,00

## A545 BLACK

LAVATÓRIO POUSAR

PRETO



CÓDIGO	MEDIDAS	€
12010317	Ø 400x125	140,00

## HA-419

LAVATÓRIO POUSAR

CINZA



CÓDIGO	MEDIDAS	€
12010282	455x320x135	155,00

# LAVATÓRIOS CERÂMICOS

## A524 GREY

LAVATÓRIO POUJAR

CINZA



CÓDIGO	MEDIDAS	€
12010276	Ø 365x120	140,00

## CM8070 PRETO

LAVATÓRIO POUJAR

PRETO MATE



CÓDIGO	MEDIDAS	€
12010318	Ø 365x120	128,00

## HC-1054

LAVATÓRIO POUJAR

BRANCO/PRATA



CÓDIGO	MEDIDAS	€
12010285	Ø 360x120	140,00

## HC-1055

LAVATÓRIO POUJAR

BRANCO/OURO



CÓDIGO	MEDIDAS	€
12010284	Ø 360x120	140,00

## WT-021

LAVATÓRIO POUJAR

MARMORE BRANCO



CÓDIGO	MEDIDAS	€
12010423	Ø 36,50x120	130,00

## 8069

LAVATÓRIO POUJAR

BRONZE MATE



CÓDIGO	MEDIDAS	€
12010290	415x135	144,00

# LAVATÓRIOS CERÂMICOS

## D51 BRONZE

LAVATÓRIO POUSAR

BRONZE BRILHO



CÓDIGO	MEDIDAS	€
12010280	Ø 415x135	144,00

## C-350B

LAVATÓRIO POUSAR

PRETO MATE



CÓDIGO	MEDIDAS	€
12010252	Ø 400x160	90,00

## HT34

LAVATÓRIO POUSAR

BRANCO/PRETO



CÓDIGO	MEDIDAS	€
12010413	550x400	140,00

## FK5038 OURO

LAVATÓRIO POUSAR

OURO



CÓDIGO	MEDIDAS	€
12010217	600x405x155	142,00

## FK5038 PRATA

LAVATÓRIO POUSAR

PRATA



CÓDIGO	MEDIDAS	€
12010218	600x405x155	142,00

## FK401

LAVATÓRIO POUSAR

MARMORE



CÓDIGO	MEDIDAS	€
12010220	475x375x130	120,00

## LAVATÓRIOS CERÂMICOS

### FK5012

LAVATÓRIO POUSAR

MARMORE



CÓDIGO	MEDIDAS	€
12010222	730x370x130	167,00

### FK5102

LAVATÓRIO POUSAR

BRANCO



CÓDIGO	MEDIDAS	€
12010244	730x370x130	160,00

### FK7078

LAVATÓRIO POUSAR

DECORADO



CÓDIGO	MEDIDAS	€
12010221	Ø 405x150	130,00

### FK5004

LAVATÓRIO POUSAR

DECORADO



CÓDIGO	MEDIDAS	€
12010223	Ø 395x155	140,00

### FS78269

LAVATÓRIO POUSAR

DECORADO



CÓDIGO	MEDIDAS	€
12010224	Ø 395x155	140,00

### HK4406

LAVATÓRIO POUSAR

BRANCO/OURO



CÓDIGO	MEDIDAS	€
12010294	Ø 405x160	165,00

## LAVATÓRIOS CERÂMICOS

### HK-8021S

LAVATÓRIO POUSAR

BRANCO/PRATA



CÓDIGO	MEDIDAS	€
12010291	Ø 415x135	165,00

### MB018Y

LAVATÓRIO POUSAR

MARMORE CREME



CÓDIGO	MEDIDAS	€
12010275	Ø 420x140	140,00

### WT-015

LAVATÓRIO POUSAR

MARMORE



CÓDIGO	MEDIDAS	€
12010424	390x390x135	130,00

### YS-1398

LAVATÓRIO POUSAR

PRETO/BRONZE



CÓDIGO	MEDIDAS	€
12010560	500x360	168,00

### K397

LAVATÓRIO POUSAR

MARMORE



CÓDIGO	MEDIDAS	€
12010427	500x400x140	140,00

### K345

LAVATÓRIO POUSAR

MARMORE



CÓDIGO	MEDIDAS	€
12010264	540x400x145	140,00

# LAVATÓRIOS CERÂMICOS

## H-8018D10

LAVATÓRIO POUJAR

MARMORE



CÓDIGO	MEDIDAS	€
12010269	500x400x145	140,00

## H-8018

LAVATÓRIO POUJAR

CINZA CLARO



CÓDIGO	MEDIDAS	€
12010416	500x400x145	140,00

## H-8018 BELEM

LAVATÓRIO POUJAR

MARMORE BELEM



CÓDIGO	MEDIDAS	€
12010415	455x320x135	140,00

## H-8018GY

LAVATÓRIO POUJAR

OURO BRILHO/BRANCO



CÓDIGO	MEDIDAS	€
12010272	500x400x145	140,00

## HY-8018B

LAVATÓRIO POUJAR

MARMORE PRETO



CÓDIGO	MEDIDAS	€
12010418	500x400	140,00

## FK8018

LAVATÓRIO POUJAR

OURO TEXTURADO/BRANCO



CÓDIGO	MEDIDAS	€
12010215	500x400x145	140,00

# LAVATÓRIOS CERÂMICOS

## H-8018 MARMORE CREME

LAVATÓRIO POUJAR

MARMORE CREME



CÓDIGO	MEDIDAS	€
12010417	500x400x145	140,00

## H-8018 ASY

LAVATÓRIO POUJAR

PRATA TEXTURADO



CÓDIGO	MEDIDAS	€
12010229	500x400x145	188,00

## H-MB013

LAVATÓRIO POUJAR

MARMORE



CÓDIGO	MEDIDAS	€
12010289	405x305x130	140,00

## H-MB014

LAVATÓRIO POUJAR

MARMORE



CÓDIGO	MEDIDAS	€
12010265	520x400x130	140,00

## WT-402

LAVATÓRIO POUJAR

MARMORE BRANCO



CÓDIGO	MEDIDAS	€
12010425	460x330x140	130,00

## WT-406

LAVATÓRIO POUJAR

MARMORE BRANCO



CÓDIGO	MEDIDAS	€
12010426	Ø 410x140	130,00

# LAVATÓRIOS CERÂMICOS

## WT-407A

LAVATÓRIO POUJAR

MARMORE BRANCO



CÓDIGO	MEDIDAS	€
12010303	560x430x150	130,00

## WT-408

LAVATÓRIO POUJAR

MARMORE BRANCO



CÓDIGO	MEDIDAS	€
12010304	500x400x135	130,00

## H-MB015

LAVATÓRIO POUJAR

PR./MARMORE



CÓDIGO	MEDIDAS	€
12010278	500x390x145	140,00

## H-MB018

LAVATÓRIO POUJAR

CINZA CLARO



CÓDIGO	MEDIDAS	€
12010273	Ø 420x140	140,00

## H-MB020

LAVATÓRIO POUJAR

MARMORE



CÓDIGO	MEDIDAS	€
12010428	365x365x140	140,00

## H-MB021

LAVATÓRIO POUJAR

MARMORE



CÓDIGO	MEDIDAS	€
12010429	410x410x150	140,00

# LAVATÓRIOS CERÂMICOS

## FHK-463

LAVATÓRIO POUSAR

BRANCO



CÓDIGO	MEDIDAS	€
12010411	450x305	120,00

## FHK-424

LAVATÓRIO POUSAR

BEJE



CÓDIGO	MEDIDAS	€
12010296	390x390	140,00

## FS-78275

LAVATÓRIO POUSAR

PRETO



CÓDIGO	MEDIDAS	€
12010225	385x385x135	140,00

## WT-0686

LAVATÓRIO POUSAR

BRANCO/OURO



CÓDIGO	MEDIDAS	€
12010322	690x420x180	188,00

## H-MB009

LAVATÓRIO POUSAR

MARMORE



CÓDIGO	MEDIDAS	€
12010421	410x410x150	140,00

## H-MB010

LAVATÓRIO POUSAR

PRETO/MARMORE OURO



CÓDIGO	MEDIDAS	€
12010268	455x320x135	140,00

# LAVATÓRIOS CERÂMICOS

**H-MB012**

LAVATÓRIO POUSAR

MARMORE



CÓDIGO	MEDIDAS	€
12010422	520x370x120	140,00

**EZ478B**

LAVATÓRIO POUSAR

PRETO MATE



CÓDIGO	MEDIDAS	€
12010307	500x420x135	183,00

**WT-8070 azul claro**

LAVATÓRIO POUSAR

AZUL CLARO



CÓDIGO	MEDIDAS	€
12010330	Ø 390x120	148,00

**WT-8070 azul**

LAVATÓRIO POUSAR

AZUL



CÓDIGO	MEDIDAS	€
12010338	Ø 390x120	148,00

**WT-8070 verde petroleo**

LAVATÓRIO POUSAR

VERDE



CÓDIGO	MEDIDAS	€
12010331	Ø 390x120	148,00

**WT-8070 verde mate**

LAVATÓRIO POUSAR

VERDE



CÓDIGO	MEDIDAS	€
12010332	Ø 390x120	148,00

# LAVATÓRIOS CERÂMICOS

## WT-8070 cinza mate

LAVATÓRIO POUSAR

CINZA



CÓDIGO	MEDIDAS	€
12010333	Ø 390x120	148,00

## WT-8070 moca

LAVATÓRIO POUSAR

MOCA



CÓDIGO	MEDIDAS	€
12010334	Ø 390x120	148,00

## WT-8070 preto mate

LAVATÓRIO POUSAR

PRETO



CÓDIGO	MEDIDAS	€
12010319	Ø 390x120	148,00

## WT-423 moca

LAVATÓRIO POUSAR

MOCA



CÓDIGO	MEDIDAS	€
12010344	385x385x135	148,00

## WT-423 azul

LAVATÓRIO POUSAR

AZUL



CÓDIGO	MEDIDAS	€
12010348	385x385x135	148,00

## WT-423 verde mate

LAVATÓRIO POUSAR

VERDE



CÓDIGO	MEDIDAS	€
12010347	385x385x135	148,00

# LAVATÓRIOS CERÂMICOS

## WT-423 azul claro

LAVATÓRIO POU SAR

AZUL CLARO



CÓDIGO	MEDIDAS	€
12010346	385x385x135	148,00

## WT-423 preto

LAVATÓRIO POU SAR

PRETO



CÓDIGO	MEDIDAS	€
12010345	385x385x135	148,00

## WT-035 branco

LAVATÓRIO POU SAR

BRANCO



CÓDIGO	MEDIDAS	€
12010430	Ø 360x180	122,00

## WT-035-1 dourado escovado/branco

LAVATÓRIO POU SAR

OURO



CÓDIGO	MEDIDAS	€
12010451	Ø 360x180	233,00

## WT-035-2 dourado listado

LAVATÓRIO POU SAR

OURO



CÓDIGO	MEDIDAS	€
12010452	Ø 360x180	290,00

## WT-035-3 antracite texturado

LAVATÓRIO POU SAR

PRETO



CÓDIGO	MEDIDAS	€
12010453	Ø 360x180	290,00

## LAVATÓRIOS CERÂMICOS

### WT-035-4 prata/ branco texturado

LAVATÓRIO POUSAR

PRATA



CÓDIGO	MEDIDAS	€
12010454	Ø 360x180	233,00

### WT-036-1 dourado texturado

LAVATÓRIO POUSAR

OURO TEXTURADO



CÓDIGO	MEDIDAS	€
12010480	Ø 360x190	290,00

### WT-036-2 dourado mate/ brilho

LAVATÓRIO POUSAR

OURO



CÓDIGO	MEDIDAS	€
12010481	Ø 360x190	290,00

### WT-036-3 dourado texturado/ branco

LAVATÓRIO POUSAR

OURO



CÓDIGO	MEDIDAS	€
12010482	Ø 360x190	290,00

### WT-036-4 dourado escovado/ preto

LAVATÓRIO POUSAR

OURO/PRETO



CÓDIGO	MEDIDAS	€
12010483	Ø 360x190	290,00

### WT-036-5 cinza

LAVATÓRIO POUSAR

CINZA



CÓDIGO	MEDIDAS	€
12010463	Ø 360x190	280,00

## LAVATÓRIOS CERÂMICOS

### WT-036-6 marmore branco

LAVATÓRIO POUJAR

MARMORE



CÓDIGO	MEDIDAS	€
12010470	Ø 360x190	233,00

### WT-036-7 preto raízes

LAVATÓRIO POUJAR

PRETO



CÓDIGO	MEDIDAS	€
12010471	Ø 360x190	290,00

### WT-037 dourado texturado/branco

LAVATÓRIO POUJAR

OURO



CÓDIGO	MEDIDAS	€
12010523	Ø 370x190	233,00

### WT-037 dourado texturado

LAVATÓRIO POUJAR

OURO



CÓDIGO	MEDIDAS	€
12010524	Ø 370x195	290,00

### YS-012 dourado/ preto

LAVATÓRIO POUJAR

OURO



CÓDIGO	MEDIDAS	€
12010550	Ø 375x130	168,00

### WT-397

LAVATÓRIO POUJAR

OURO



CÓDIGO	MEDIDAS	€
12010323	Ø 397x135	290,00

# LAVATÓRIOS SOLID SURFACE

## SQUARE LINE

LAVATÓRIO POU SAR RETANGULAR



50 x 32 x 8cm  
Profundidade: 7cm

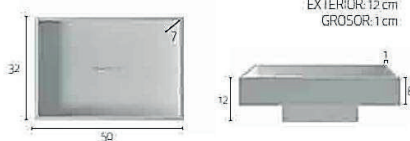

CÓDIGO	MEDIDAS	€
12014001	500x320x80	583,00

## FLÓRIDA

LAVATÓRIO POU SAR RETANGULAR

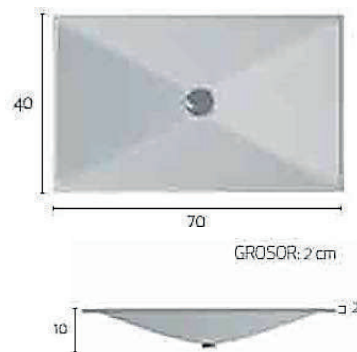

CÓDIGO	MEDIDAS	€
12014002	700x400x100	443,00

## QUADRO

LAVATÓRIO POU SAR QUADRADO

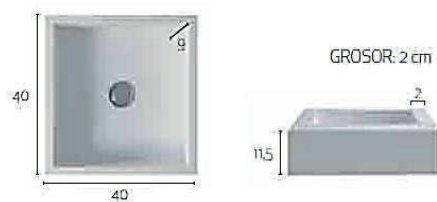

CÓDIGO	MEDIDAS	€
12014003	400x400x115	528,00

## SQUARE

LAVATÓRIO POU SAR RETANGULAR

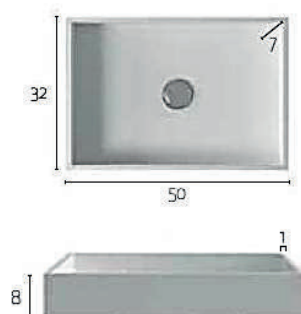

CÓDIGO	MEDIDAS	€
12014005	500x320x80	394,00

# LAVATÓRIOS SOLID SURFACE

## COSO

LAVATÓRIO POUSAR REDONDO

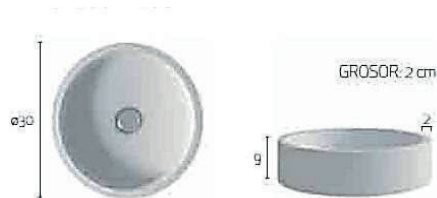

CÓDIGO	MEDIDAS	€
12014007	Ø 300x90	462,00

## ROMA

LAVATÓRIO POUSAR QUADRADO

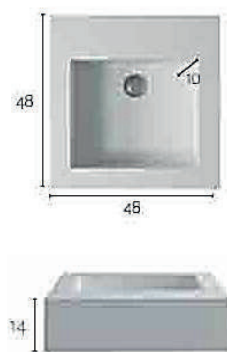

CÓDIGO	MEDIDAS	€
12014008	480x480x140	652,00

## SEATTLE

LAVATÓRIO POUSAR RETANGULAR C/ VALVULA OCULTA

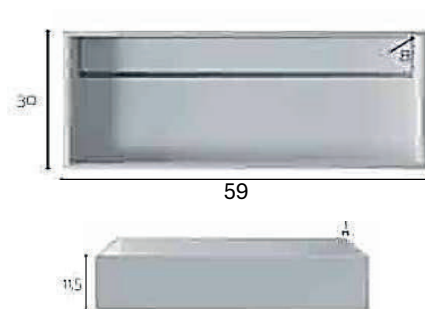

CÓDIGO	MEDIDAS	€
12014009	590x300x115	811,00

## FRUIT

LAVATÓRIO POUSAR REDONDO TIPO ESFERA

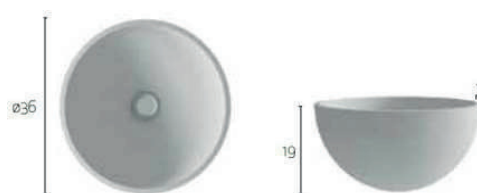

CÓDIGO	MEDIDAS	€
12014010	Ø 360x190	504,00

# LAVATÓRIOS SOLID SURFACE

## PADOVA

medidas da cuba 48x32x9cm



MEDIDAS	60	70	80	90	100	110	120	130	140	150	160	170	180	190	200
<b>CUBA AO CENTRO, DIREITA OU ESQUERDA</b>															
S/PAINEL €	474	550	629	679	703	774	843	914	983	1055	1124	1195	1264	1136	1406
C/PAINEL €	687	800	911	987	1019	1121	1223	1326	1426	1528	1602	1733	1833	1934	2071
<b>DUPLO</b>															
S/PAINEL €	•	•	•	•	•	•	1144	1224	1293	1383	1459	1521	1557	1579	1603
C/PAINEL €	•	•	•	•	•	•	1524	1635	1741	1854	1962	2057	2124	2181	2250

## GAMA

medidas da cuba 46,5x28x8,5cm



MEDIDAS	60	70	80	90	100	110	120	130	140	150	160	170	180	190	200
<b>CUBA AO CENTRO, DIREITA OU ESQUERDA</b>															
S/PAINEL €	474	550	629	679	703	774	843	914	983	1055	1124	1195	1264	1336	1405
C/PAINEL €	687	800	911	987	1019	1121	1223	1326	1425	1528	1601	1733	1833	1935	2070
<b>DUPLO</b>															
S/PAINEL €	•	•	•	•	•	•	1145	1224	1293	1383	1459	1521	1557	1579	1603
C/PAINEL €	•	•	•	•	•	•	1524	1634	1741	1853	1962	2057	2124	2181	2250

## TABAC

medidas da cuba 44x30,5x13cm



MEDIDAS	60	70	80	90	100	110	120	130	140	150	160	170	180	190	200
<b>CUBA AO CENTRO, DIREITA OU ESQUERDA</b>															
S/PAINEL €	474	550	629	679	703	774	843	914	983	1055	1124	1195	1264	1336	1405
C/PAINEL €	687	800	911	987	1019	1121	1223	1326	1425	1528	1601	1733	1833	1935	2070
<b>DUPLO</b>															
S/PAINEL €	•	•	•	•	•	•	1145	1224	1293	1383	1459	1521	1557	1579	1603
C/PAINEL €	•	•	•	•	•	•	1524	1634	1741	1853	1962	2057	2124	2181	2250

## NEVADA

medidas da cuba 80x35x11cm



MEDIDAS	60	70	80	90	100	110	120	130	140	150	160	170	180	190	200		
<b>CUBA AO CENTRO, DIREITA OU ESQUERDA</b>																	
S/PAINEL €	•	•	•	704	781	859	937	1016	1092	1171	1242	1328	1404	1490	1563		
C/PAINEL €	•	•	•	1125	1156	1280	1356	1471	1581	1699	1809	1923	2035	2150	2266		
<b>MEDIDAS</b>																	
											180	190	200	210	220	230	240
<b>DUPLO</b>																	
S/PAINEL €	•	•	•	•	•	•	•	•	•	•	1594	1669	1749	1828	1907	1983	2062
C/PAINEL €	•	•	•	•	•	•	•	•	•	•	2225	2338	2454	2575	2697	2819	2940

## BALTIMORE

medidas da cuba 65x30x12cm



MEDIDAS	60	70	80	90	100	110	120	130	140	150	160	170	180	190	200
<b>CUBA AO CENTRO, DIREITA OU ESQUERDA</b>															
S/PAINEL €	•	550	630	680	704	775	844	914	983	1056	1125	1195	1264	1337	1406
C/PAINEL €	•	800	911	987	1019	1121	1223	1326	1426	1528	1602	1733	1833	1935	2071
<b>DUPLO</b>															
S/PAINEL €	•	•	•	•	•	•	•	•	1294	1383	1459	1521	1557	1580	1604
C/PAINEL €	•	•	•	•	•	•	•	•	1742	1854	1962	2057	2125	2181	2250

# LAVATÓRIOS SOLID SURFACE

## CALIFÓRNIA

medidas da cuba 62x36x10cm



MEDIDAS	60	70	80	90	100	110	120	130	140	150	160	170	180	190	200
<b>CUBA AO CENTRO, DIREITA OU ESQUERDA</b>															
S/PAINEL €	•	550	630	680	704	775	844	914	983	1056	1125	1195	1264	1337	1406
C/PAINEL €	•	800	911	987	1019	1121	1223	1326	1426	1528	1602	1733	1833	1935	2071
<b>DUPLO</b>															
S/PAINEL €	•	•	•	•	•	•	•	•	1294	1383	1459	1521	1557	1580	1604
C/PAINEL €	•	•	•	•	•	•	•	•	1742	1854	1962	2057	2125	2181	2250

## FOLK

medidas da cuba 49x30x13cm



MEDIDAS	60	70	80	90	100	110	120	130	140	150	160	170	180	190	200
<b>CUBA AO CENTRO, DIREITA OU ESQUERDA</b>															
S/PAINEL €	475	550	630	680	704	775	844	914	983	1056	1125	1195	1264	1337	1406
C/PAINEL €	687	800	911	987	1019	1121	1223	1326	1426	1528	1602	1733	1833	1935	2071
<b>DUPLO</b>															
S/PAINEL €	•	•	•	•	•	•	1145	1225	1294	1383	1459	1521	1557	1580	1604
C/PAINEL €	•	•	•	•	•	•	1525	1635	1742	1854	1962	2057	2125	2181	2250

## PISA

medidas da cuba Ø34,5x11cm



MEDIDAS	60	70	80	90	100	110	120	130	140	150	160	170	180	190	200
<b>CUBA AO CENTRO, DIREITA OU ESQUERDA</b>															
S/PAINEL €	475	550	630	680	704	775	844	914	983	1056	1125	1195	1264	1337	1406
C/PAINEL €	687	800	911	987	1019	1121	1223	1326	1426	1528	1602	1733	1833	1935	2071
<b>DUPLO</b>															
S/PAINEL €	•	•	•	•	•	•	1145	1225	1294	1383	1459	1521	1557	1580	1604
C/PAINEL €	•	•	•	•	•	•	1525	1635	1742	1854	1962	2057	2125	2181	2250

## ITALO

medidas da cuba 45x28x10cm



MEDIDAS	60	70	80	90	100	110	120	130	140	150	160	170	180	190	200
<b>CUBA AO CENTRO, DIREITA OU ESQUERDA</b>															
S/PAINEL €	475	550	630	680	704	775	844	914	983	1056	1125	1195	1264	1337	1406
C/PAINEL €	687	800	911	987	1019	1121	1223	1326	1426	1528	1602	1733	1833	1935	2071
<b>DUPLO</b>															
S/PAINEL €	•	•	•	•	•	•	1145	1225	1294	1383	1459	1521	1557	1580	1604
C/PAINEL €	•	•	•	•	•	•	1525	1635	1742	1854	1962	2057	2125	2181	2250

# LAVATÓRIOS SOLID SURFACE

## TENNESSEE

medidas da cuba 45x36x9cm



MEDIDAS	60	70	80	90	100	110	120	130	140	150	160	170	180	190	200	
<b>CUBA AO CENTRO</b>																
C/PAINEL €	•	•	•	1125	1156	1280	1356	1471	1581	1699	1809	1923	2035	2150	2266	
<b>DUPLO</b>																
MEDIDAS				120	130	140	150	160	170	180	190	200	210	220	230	240
C/PAINEL €	•	•	•	1544	1659	1769	1885	1997	2111	2225	2338	2454	2575	2697	2819	2940

## EFE

medidas da cuba 42x28x9cm



MEDIDAS	60	70	80	90	100	110	120	130	140	150	160	170	180	190	200
<b>CUBA AO CENTRO</b>															
S/PAINEL €	378	440	502	545	571	628	685	740	781	852	907	966	1021	1078	1133
C/PAINEL €	599	661	723	764	790	847	904	957	1014	1071	1126	1183	1238	1293	1357
<b>DUPLO</b>															
S/PAINEL €	•	•	•	•	•	•	949	1073	1133	1194	1254	1314	1375	1435	1495
C/PAINEL €	•	•	•	•	•	•	1275	1373	1433	1494	1554	1614	1735	1795	1856

## PARIS

medidas da cuba 70x30x10cm



MEDIDAS	60	70	80	90	100	110	120	130	140	150	160	170	180	190	200
<b>CUBA AO CENTRO</b>															
S/PAINEL €	•	•	•	704	781	859	937	1016	1092	1171	1242	1328	1404	1490	1562
C/PAINEL €	•	•	•	1125	1156	1280	1356	1471	1581	1699	1809	1923	2035	2150	2266
<b>DUPLO</b>															
MEDIDAS							160	170	180	190	200	210	220	230	240
S/PAINEL €	•	•	•	•	•	•	1435	1516	1594	1669	1749	1828	1907	1983	2063
C/PAINEL €	•	•	•	•	•	•	1997	2111	2225	2338	2454	2575	2697	2819	2940

## CHICLANA

medidas da cuba 110x35x13cm



MEDIDAS	60	70	80	90	100	110	120	130	140	150	160	170	180	190	200
<b>CUBA AO CENTRO</b>															
S/PAINEL €	•	•	•	•	•	•	937	1016	1092	1171	1242	1328	1404	1490	1562
C/PAINEL €	•	•	•	•	•	•	1356	1471	1581	1699	1809	1923	2035	2150	2266

# Lavatórios Inox



# LAVATÓRIOS INOX

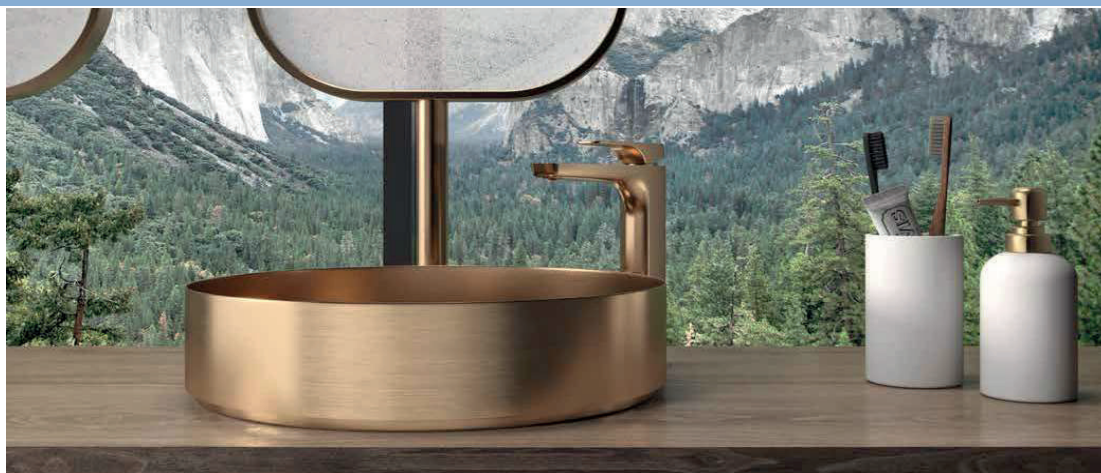

## FLS 400 cor bronze escovado

LAVATÓRIO INOX POUSAR



CÓDIGO	MEDIDA	€
12030205	Ø 406x120	542,00

## FLS-400 dourado escovado

LAVATÓRIO INOX POUSAR



CÓDIGO	MEDIDA	€
12030202	Ø 406x120	542,00

## FLS-400 metalizado cinza

LAVATÓRIO INOX POUSAR



CÓDIGO	MEDIDA	€
12030204	Ø 406x120	542,00

## FLS-400 preto mate

LAVATÓRIO INOX POUSAR



CÓDIGO	MEDIDA	€
12030201	Ø 406x120	542,00

\* VALVULA INCLUÍDA

# LAVATÓRIOS INOX

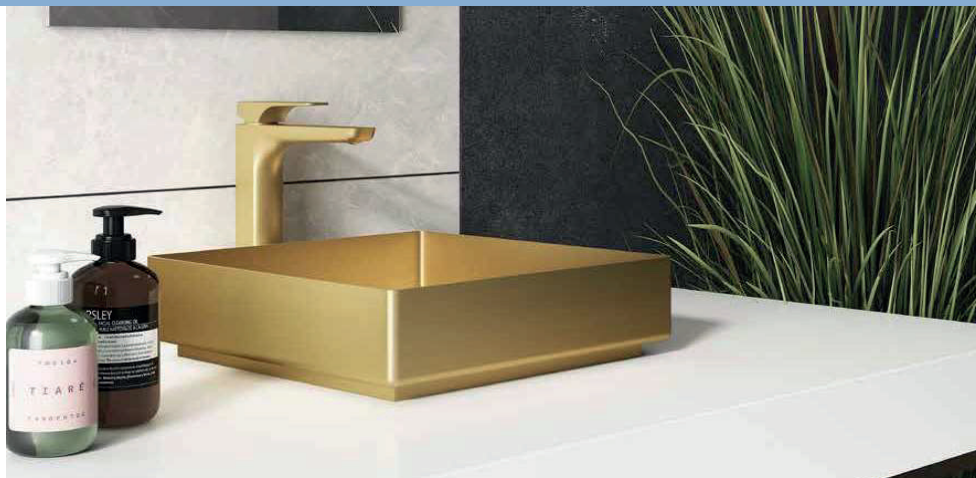

## FLS 4040 cor bronze escovado

LAVATÓRIO INOX POUSAR

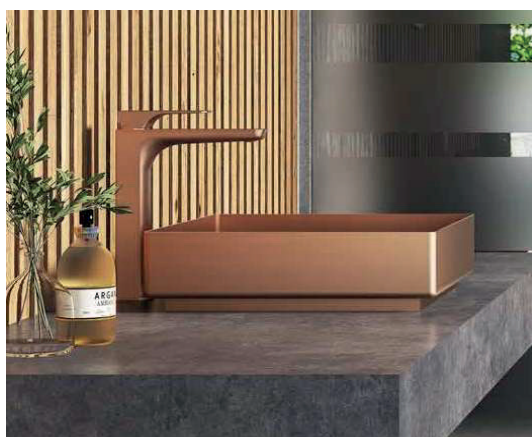

CÓDIGO	MEDIDA	€
12030215	406x406x120	542,00

## FLS 4040 dourado escovado

LAVATÓRIO INOX POUSAR



CÓDIGO	MEDIDA	€
12030212	406x406x120	542,00

## FLS 4040 metalizado cinza

LAVATÓRIO INOX POUSAR



CÓDIGO	MEDIDA	€
12030214	406x406x120	542,00

## FLS 4040 preto mate

LAVATÓRIO INOX POUSAR



CÓDIGO	MEDIDA	€
12030211	406x406x120	542,00

\* VALVULA INCLUÍDA

# LAVATÓRIOS INOX

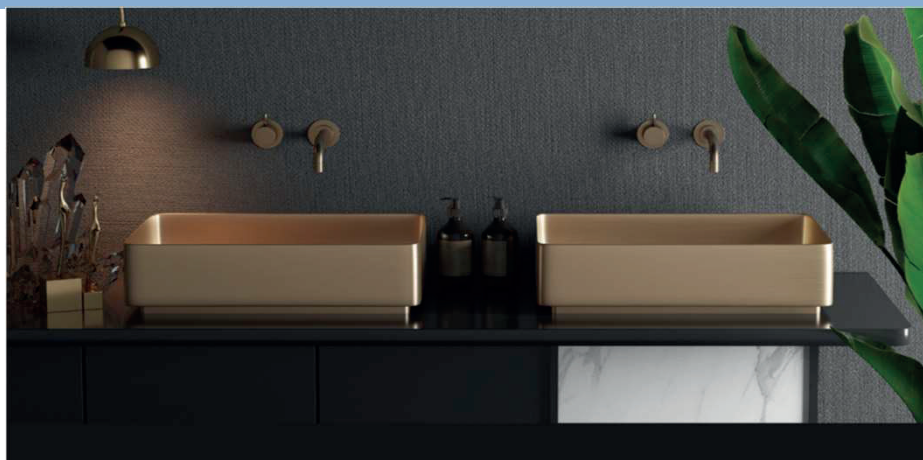

## FLS 3452 cor bronze escovado

LAVATÓRIO INOX POUSAR



CÓDIGO	MEDIDA	€
12030225	526x346x120	565,00

## FLS 3452 dourado escovado

LAVATÓRIO INOX POUSAR

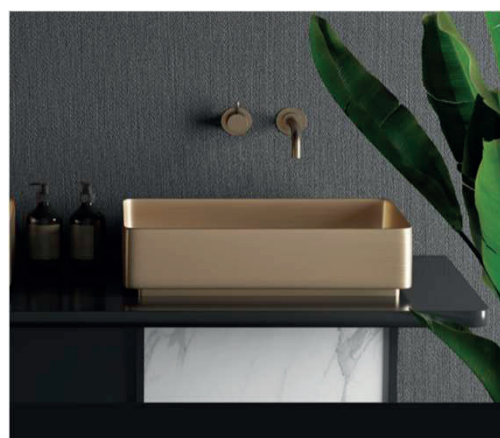

CÓDIGO	MEDIDA	€
12030222	526x346x120	565,00

## FLS 3452 metalizado cinza

LAVATÓRIO INOX POUSAR

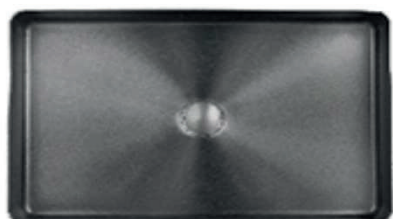

CÓDIGO	MEDIDA	€
12030224	526x346x120	565,00

## FLS 3452 preto mate

LAVATÓRIO INOX POUSAR



CÓDIGO	MEDIDA	€
12030221	526x346x120	565,00

\* VALVULA INCLUÍDA

## PIOS VIDRO

### P-GOLD84

LAVATÓRIO POU SAR

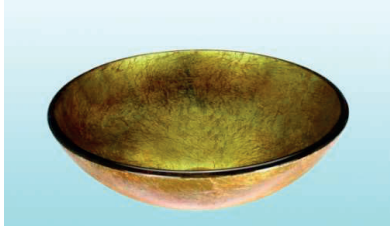

CÓDIGO	MEDIDAS	€
12020132	Ø 450x150	155,00

### P-N02

LAVATÓRIO POU SAR



CÓDIGO	MEDIDAS	€
12020134	Ø 420x150	155,00

### P-N132

LAVATÓRIO POU SAR



CÓDIGO	MEDIDAS	€
12020135	Ø 420x150	155,00

### P-S92

LAVATÓRIO POU SAR



CÓDIGO	MEDIDAS	€
12020136	Ø 420x150	155,00

### P-S85

LAVATÓRIO POU SAR



CÓDIGO	MEDIDAS	€
12020185	Ø 420x150	155,00

### P-S88

LAVATÓRIO POU SAR



CÓDIGO	MEDIDAS	€
12020140	Ø 420x150	155,00

### P-S86

LAVATÓRIO POU SAR



CÓDIGO	MEDIDAS	€
12020141	Ø 420x150	155,00

### P-S76

LAVATÓRIO POU SAR



CÓDIGO	MEDIDAS	€
12020147	Ø 420x150	155,00

### P-S91

LAVATÓRIO POU SAR



CÓDIGO	MEDIDAS	€
12020154	Ø 420x150	155,00

### P-S79

LAVATÓRIO POU SAR



CÓDIGO	MEDIDAS	€
12020149	Ø 420x150	155,00

### P-HJG191

LAVATÓRIO POU SAR



CÓDIGO	MEDIDAS	€
12020153	Ø 420x150	155,00

### P-Y160

LAVATÓRIO POU SAR



CÓDIGO	MEDIDAS	€
12020142	544x342x150	155,00

## PIOS VIDRO

### P-10 PRETO

LAVATÓRIO POUSAR



CÓDIGO	MEDIDAS	€
12020110	Ø 420x150	98,00

### P-8

LAVATÓRIO POUSAR



CÓDIGO	MEDIDAS	€
12020108	Ø 410x150	90,00

### P-20

LAVATÓRIO POUSAR



CÓDIGO	MEDIDAS	€
12020120	412x421x150	90,00

### LAVATÓRIO VIDRO MODELO

PACIFICO

MED.	CÓDIGO						€
	BRANCO	LARANJA	VERDE	MET. ALU	PRETO		
60x46	13PC6002	13PC6004	13PC6005	13PC6003	13PC6011		315,00
80x46	13PC8002	13PC8004	13PC8005	13PC8003	13PC8011		330,00
90x46	13PC9002	13PC9004	13PC9005	13PC9003	13PC9011		350,00
100x46	13PC1002	13PC1004	13PC1005	13PC1003	13PC1011		370,00
120x46	13PC1202	13PC1204	13PC1205	13PC1203	13PC1211		395,00



• Fabricamos outras medidas e cores, consultar.

• Fabricamos c/ Pio à Esquerda ou Direita, Preços consultar.

• Estrutura não incluída.

## PIOS INOX

### SEM RESPIRO

LAVATÓRIO ENCASTRAR



CÓDIGO	MEDIDAS	€
12030105	int. / ext. Ø 260x305	79,00
12030111	Ø 310x355	95,00
12030113	Ø 355x405	112,00

### COM RESPIRO

LAVATÓRIO ENCASTRAR



CÓDIGO	MEDIDAS	€
12010334	int. / ext. Ø 260x305	84,00
12010335	Ø 310x355	107,40
12010337	Ø 355x405	120,00

# MÓVEIS

## HAWAY

MÓVEL COM 2 GAVETÕES E PÉS



MEDIDAS	€
Móvel 60 cm Branco	243,00
Móvel 60 cm Branco/Cor	273,00
Móvel 80 cm Branco	270,00
Móvel 80 cm Branco/Cor	300,00
Móvel 100 cm Branco	310,00
Móvel 100 cm Branco/Cor	334,00
Lavatório cerâmico tipo bancada 60x46	70,00
Lavatório cerâmico tipo bancada 80x46	74,00
Lavatório cerâmico tipo bancada 100x46	106,00

## SABINE

MÓVEL COM 2 GAVETÕES E PÉS



MEDIDAS	€
Móvel 60 cm Branco	243,00
Móvel 60 cm Branco/Cor	273,00
Móvel 80 cm Branco	274,00
Móvel 80 cm Branco/Cor	300,00
Móvel 100 cm Branco	310,00
Móvel 100 cm Branco/Cor	334,00
Lavatório cerâmico tipo bancada 60x46	70,00
Lavatório cerâmico tipo bancada 80x46	74,00
Lavatório cerâmico tipo bancada 100x46	106,00

## MARA

MÓVEL COM 2 GAVETÕES E PÉS



MEDIDAS	€
Móvel 80 cm Branco	293,00
Móvel 80 cm Branco/Cor	300,00
Móvel 100 cm Branco	320,00
Móvel 100 cm Branco/Cor	350,00
Lavatório cerâmico tipo bancada 80x46	74,00
Lavatório cerâmico tipo bancada 100x46	106,00

# MÓVEIS

## GIANI

MÓVEL SUSPENSO COM 2 GAVETÕES



### MEDIDAS

	€
Móvel 60 cm branco	242,00
Móvel 60 cm Frente lacada cor	248,00
Móvel 80 cm branco	300,00
Móvel 80 cm Frente lacada cor	330,00
Móvel 100 cm branco	350,00
Móvel 100 cm Frente lacada cor	378,00
Lavatório cerâmico tipo bancada 60x46	70,00
Lavatório cerâmico tipo bancada 80x46	74,00
Lavatório cerâmico tipo bancada 100x46	106,00

## GIANI 120

MÓVEL SUSPENSO COM 2 GAVETÕES



### MEDIDAS

	€
Móvel 120 cm Branco	580,00
Móvel 120 cm Branco/cor	648,00
Lavatório cerâmico 2 Pios 120cm	198,00

## SOL

MÓVEL SUSPENSO COM 1 GAVETÃO



### MEDIDAS

	€
Móvel 60 cm Branco	268,00
Móvel 60 cm Cor	316,00
Móvel 80 cm Branco	296,00
Móvel 80 cm Cor	368,00
Organizador 60 cm	46,00
Organizador 80 cm	61,00
Lavatório cerâmico tipo bancada 60x46	70,00
Lavatório cerâmico tipo bancada 80x46	74,00

# MÓVEIS

## MUSA

MÓVEL COM 3 GAVETÕES E PÉS



### MEDIDAS

	€
Móvel 80 cm Branco/Cores	377,00
Móvel 100 cm Branco/Cores	408,00
Lavatório cerâmico tipo bancada 80x46	74,00
Lavatório cerâmico tipo bancada 100x46	106,00

## MAIA

MÓVEL SUSPENSO COM 2 GAVETÕES



### MEDIDAS

	€
Móvel 60cm Branco	251,00
Móvel 60 cm Branco/Cor	281,00
Móvel 80 cm Branco	282,00
Móvel 80 cm Branco/Cor	312,00
Móvel 100 cm Branco	315,00
Móvel 100 cm Branco/Cor	345,00
Lavatório cerâmico tipo bancada 60x46	70,00
Lavatório cerâmico tipo bancada 80x46	74,00
Lavatório cerâmico tipo bancada 100x46	106,00

## ZEUS

MÓVEL COM 1 PORTA + 2 GAVETAS COM PÉS



### MEDIDAS

	€
Móvel 50 cm Branco/Wengué/Zermat/Cinza/Joplin	112,00
Móvel 60 cm Branco/Wengué/Zermat/Cinza/Joplin	122,00
Móvel 70cm Branco/Wengué/Zermat/Cinza/Joplin	140,00
Móvel 80 cm Branco/Wengué/Zermat/Cinza/Joplin	143,00
Móvel 100 cm Branco/Wengué/Zermat/Cinza/Joplin	180,00
Móvel 120 cm Branco/Wengué/Zermat/Cinza/Joplin	196,00

*Medidas de 70cm a 120cm contém 2 portas + 2 gavetas*

# MÓVEIS

## STRATO

MÓVEL SUSPENSO COM 2 PORTAS E 4 GAVETÕES



### MEDIDAS

	€
Móvel 120 cm	230,00
Lavatório cerâmico 1 Pio 120x46	162,00
Lavatório cerâmico 2 Pio 120x46	190,00

## ZEUS COM PÉS

MÓVEL COM 2 PORTAS + 4 GAVETAS COM PÉS



### MEDIDAS

	€
Móvel 120 cm	230,00
Lavatório cerâmico 1 Pio 120x46	162,00
Lavatório cerâmico 2 Pios 120x46	190,00

## STRATO

MÓVEL SUSPENSO COM 2 PORTAS E 2 GAVETAS



### MEDIDAS

	€
Móvel 50 cm	112,00
Móvel 60 cm	122,00
Móvel 70 cm	140,00
Móvel 80 cm	143,00
Móvel 100 cm	180,00
Lavatório cerâmico tipo bancada 50x46	70,00
Lavatório cerâmico tipo bancada 60x46	70,00
Lavatório cerâmico tipo bancada 70x46	72,00
Lavatório cerâmico tipo bancada 80x46	74,00

Medidas de 50cm e 60cm contém 1 porta + 1 gaveta

# MÓVEIS

## ECO

MÓVEL COM 2 PORTAS E COM PÉS



MEDIDAS	€
Móvel 50 cm	90,00
Móvel 60cm	96,00
Móvel 70 cm	110,00
Móvel 80 cm	112,00
Móvel 100 cm	160,00
Móvel 120 cm	180,00

*Medidas de 100cm e 120cm contém 3 portas*

## ANIDIS

MÓVEL SUSPENSO COM 2 PORTAS



MEDIDAS	€
Móvel 50 cm Branco/Wengué	90,00
Móvel 60 cm Branco/Wengué	96,00
Móvel 70 cm Branco/Wengué	110,00
Móvel 80 cm Branco/Wengué	112,00
Móvel 100 cm Branco/Wengué	160,00
Móvel 120 cm Branco/Wengué	180,00

*Medidas de 100cm e 120cm contém 3 portas*

## ANIDIS

MÓVEL SUSPENSO COM 2 PORTAS



MEDIDAS	€
Móvel 50 cm Branco/Cor	120,00
Móvel 60 cm Branco/Cor	126,00
Móvel 70 cm Branco/Cor	140,00
Móvel 80 cm Branco/Cor	142,00
Móvel 100 cm Branco/Cor	190,00
Lavatório cerâmico tipo bancada 50x46	70,00
Lavatório cerâmico tipo bancada 60x46	70,00
Lavatório cerâmico tipo bancada 70x46	72,00
Lavatório cerâmico tipo bancada 80x46	74,00
Lavatório cerâmico tipo bancada 100x46	74,00

*Medida de 100cm contém 3 portas*

# MÓVEIS

## ITALIA

MÓVEL COM 2 PORTAS + 1 GAVETÃO COM PÉS



### MEDIDAS

	€
Móvel 60 cm Branco/Joplin/Cambrian	136,00
Móvel 80 cm Branco/Joplin/Cambrian	160,00
Lavatório cerâmico tipo bancada 60x46	70,00
Lavatório cerâmico tipo bancada 80x46	74,00

## AXIS

MÓVEL SUSPENSO COM 2 GAVETÕES



### MEDIDAS

	€
Móvel 60 cm Branco	190,00
Móvel 70 cm Branco	197,00
Móvel 80 cm Branco	208,00
Móvel 100 cm Branco	225,00
Móvel 120 cm Branco	252,00

\* DOBRADIÇAS SOFT CLOSE REFORÇADAS

## OEIRAS

MÓVEL COM 3 GAVETAS E PÉS



### MEDIDAS

	€
Móvel 60 cm Branco	288,00
Móvel 80 cm Branco	320,00
Móvel 100 cm Branco	352,00
Lavatório cerâmico tipo bancada 60x46	70,00
Lavatório cerâmico tipo bancada 80x46	74,00
Lavatório cerâmico tipo bancada 100x46	106,00

\* DOBRADIÇAS SOFT CLOSE REFORÇADAS

# MÓVEIS

## MATEUS

MÓVEL COM 2 PORTAS E COM PÉS



### MEDIDAS

	€
Móvel 60 cm Branco/Marmol/Alumínio/ Wengué	135,00
Móvel 80 cm Branco/Marmol/Alumínio/ Wengué	152,00
Lavatório cerâmico tipo bancada 60x46	70,00
Lavatório cerâmico tipo bancada 80x46	74,00

## MARSELHA SUSPENSO

MÓVEL SUSPENSO COM 2 GAVETÕES



### MEDIDAS

	€
Móvel 60cm Branco	160,00
Móvel 60cm Linho/Zermatt/Cinza/Joplin/Cambrian	162,00
Móvel 80cm suspenso Branco	177,00
Móvel 80cm Linho/Zermatt/Cinza/Joplin/Cambrian	180,00
Móvel 100cm suspenso Branco	210,00
Móvel 100cm Linho/Zermatt/Cinza/Joplin/Cambrian	215,00
Móvel 120 cm suspenso Branco	280,00
Móvel 120cm Linho/Zermatt/Cinza/Joplin/Cambrian	285,00

## MARSELHA SUSPENSO

MÓVEL SUSPENSO COM 4 GAVETÕES



### MEDIDAS

	€
Móvel 120cm suspenso Branco	350,00
Móvel 120cm suspenso Linho	360,00
Lavatório cerâmico 2 Pios 120x46	190,00

# MÓVEIS

## MARSELHA COM PÉS

MÓVEL COM 3 GAVETÕES E PÉS



### MEDIDAS

	€
Móvel 60 cm Branco	189,00
Móvel 60 cm Linho/Zermatt/Cinza/Joplin/Cambrian	190,00
Móvel 80 cm Branco	213,00
Móvel 80 cm Linho/Zermatt/Cinza/Joplin/Cambrian	215,00
Móvel 100 cm Branco	243,00
Móvel 100 cm Linho/Zermatt/Cinza/Joplin/Cambrian	245,00
Móvel 120 cm Branco	343,00
Móvel 120 cm Linho/Zermatt/Cinza/Joplin/Cambrian	345,00
Lavatório cerâmico tipo bancada 60x46	70,00
Lavatório cerâmico tipo bancada 80x46	74,00
Lavatório cerâmico tipo bancada 100x46	106,00

## TAMPOS (espessura 16mm)

TAMPO P/ SUBSTITUIR LAVAT. ENCASTRAR

ACABAMENTO	MEDIDA	€
BRANCO/ CORES	60	24,00
BRANCO/ CORES	70	28,00
BRANCO/ CORES	80	30,00
BRANCO/ CORES	100	36,00
BRANCO/ CORES	120	48,00

### ACABAMENTOS:

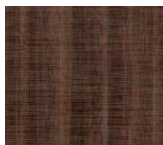

FRESNO

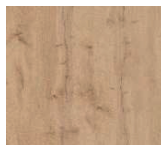

HÉRCULES



JOPLIM



CAMBRIAN

# AUXILIARES

## MESITA

C/ TAMPO, 1 GAVETA E 1 PORTA



CÓDIGO	MEDIDA	€
13040126	40 cm	120,00
13040128	60 cm	143,00

## MESITA

C/ TULHA E PÉS BRANCA



CÓDIGO	MEDIDA	€
13040121	40 cm	136,00
13040120	60 cm	167,00

## ZEUS

COLUNA C/ PÉS BRANCA

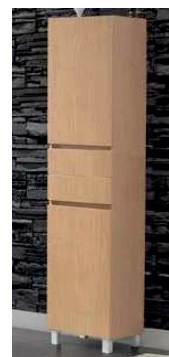

CÓDIGO	MEDIDA	€
13040143	40 cm	212,00
13040144	60 cm	275,00

## ZEUS C/ PUXADOR

COLUNA C/ PÉS BRANCA

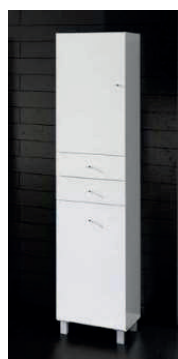

CÓDIGO	MEDIDA	€
13040133	140x40x33	215,00

## COLUNA

C/ PÉS, 4 PORTAS E 2 GAVETAS



CÓDIGO	MEDIDA	€
13040137	180x60x33	236,00

## HAWAY

COLUNA SUSPENSA BRANCA



CÓDIGO	MEDIDA	€
13040272	140x40x33	195,00

## ECO

COLUNA SUSPENSA BRANCA



CÓDIGO	MEDIDA	€
13040271	112x30x33	134,00

## MATEUS

MEIA COLUNA C/ PÉS BRANCA



CÓDIGO	MEDIDA	€
13040146	148x140x33	174,00

## COLUNA

COLUNA C/ PÉS, TULHA E 2 GAVETAS



CÓDIGO	MEDIDA	€
13040131	180x40x33	265,00

# ESPELHOS LED

## C02 orla foscada

ESPELHO C/ TOUCH + DESEMBACIADOR



TOUCH ON/OFF



LUZ LED



DESEMBACIADOR

CÓDIGO	MEDIDAS	€
14020302	600 Ø	114,00
14020322	800 Ø	154,00

## C02 OVAL orla foscada

ESPELHO C/ TOUCH + DESEMBACIADOR



CÓDIGO	MEDIDAS	€
14020702	600x800	153,00

## C03

ESPELHO C/ TOUCH + DESEMBACIADOR



CÓDIGO	MEDIDA	€
14020402	Ø 600	128,00
14020422	Ø 800	167,00

## C06 orla foscada

ESPELHO C/ TOUCH + DESEMBACIADOR



CÓDIGO	MEDIDA	€
14020432	Ø 600	125,00
14020442	Ø 800	162,00

# ESPELHOS LED

**C07**

PERFIL PRETO

ESPELHO C/ TOUCH + DESEMBACIADOR



CÓDIGO	MEDIDAS	€
14020452	Ø 600	138,00
14020472	Ø 800	157,00

**C08**

PERFIL PRETO

ESPELHO C/ TOUCH + DESEMBACIADOR



CÓDIGO	MEDIDAS	€
14022143	600x1000	114,00

**R02 orla foscada**

ESPELHO C/ TOUCH + DESEMBACIADOR

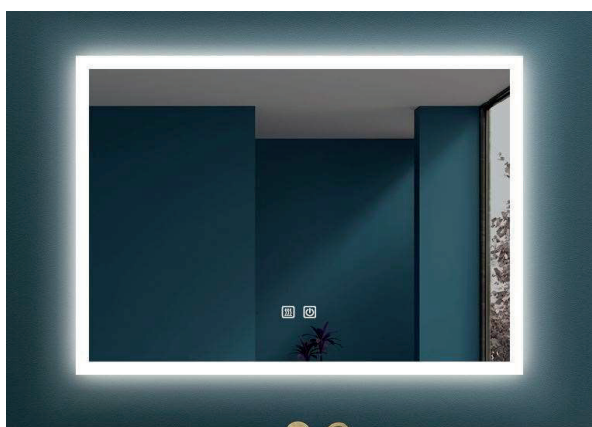

CÓDIGO	MEDIDAS	€
14020922	800x600	127,00
14020932	800x800	161,00
14020942	1000x700	191,00
14020952	1000x800	205,00
14020972	1200x700	220,00
14020982	1200x800	230,00

**R06**

ESPELHO C/ TOUCH + DESEMBACIADOR

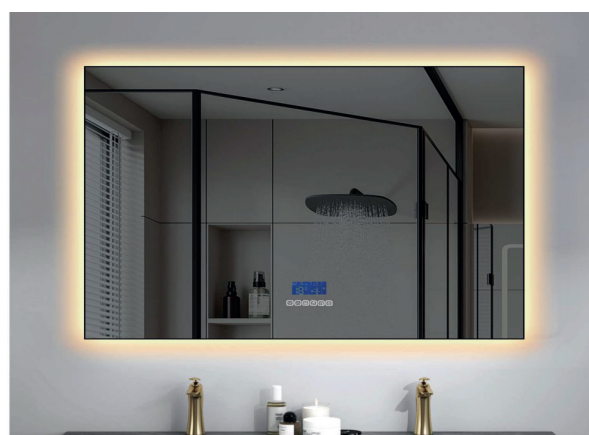

CÓDIGO	MEDIDAS	€
14021522	800x600	127,00
14021532	800x800	161,00
14021542	1000x700	191,00
14021552	1000x800	205,00
14021572	1200x700	220,00
14021582	1200x800	230,00

# ESPELHOS LED

## R08 orla foscada

ESPELHO C/ TOUCH + DESEMBACIADOR



TOUCH ON/OFF



LUZ LED



DESEMBACIADOR

CÓDIGO	MEDIDAS	€
14021722	800x600	132,00
14021732	800x800	156,00
14021742	1000x700	157,00
14021752	1000x800	191,00

## R03

ESPELHO C/ TOUCH + DESEMBACIADOR



CÓDIGO	MEDIDAS	€
14021022	800x600	127,00
14021032	800x800	153,00
14021042	1000x700	154,00
14021052	1000x800	160,00
14023282	1200x800	180,00

## R05

ESPELHO C/ TOUCH + DESEMBACIADOR



CÓDIGO	MEDIDAS	€
14021422	800x600	127,00
14021432	800x800	141,00
14021442	1000x700	154,00
14021452	1000x800	160,00

## R07

ESPELHO C/ TOUCH + DESEMBACIADOR



CÓDIGO	MEDIDAS	€
14021622	600x800	127,00
14021642	700x1000	154,00
14021652	800x1000	164,00

# ESPELHOS LED

## WT-001

ESPELHO C/ TOUCH + DESEMBACIADOR



TOUCH ON/OFF



LUZ LED



DESEMBACIADOR

CÓDIGO	MEDIDAS	€
14022142	600x1500	398,00

## WT-040

PERFIL PRETO

ESPELHO C/ TOUCH + DESEMBACIADOR



CÓDIGO	MEDIDAS	€
14022153	Ø 600	235,00
14022173	Ø 800	235,00

## WT-040

PERFIL DOURADO

ESPELHO C/ TOUCH + DESEMBACIADOR



CÓDIGO	MEDIDAS	€
14022154	Ø 600	235,00
14022174	Ø 800	250,00

## WT-040-P

PERFIL DOURADO

ESPELHO C/ TOUCH + DESEMBACIADOR



OURO		
CÓDIGO	MEDIDAS	€
14022334	Ø 800	325,00

PRETO		
CÓDIGO	MEDIDAS	€
14022333	Ø 800	325,00

# ESPELHOS LED

**WT-045**

PERFIL PRETO

ESPELHO C/ TOUCH + DESEMBACIADOR



TOUCH ON/OFF



LUZ LED



DESEMBACIADOR

CÓDIGO	MEDIDAS	€
14022443	600x1000	325,00

**WT-045**

PERFIL DOURADO

ESPELHO C/ TOUCH + DESEMBACIADOR

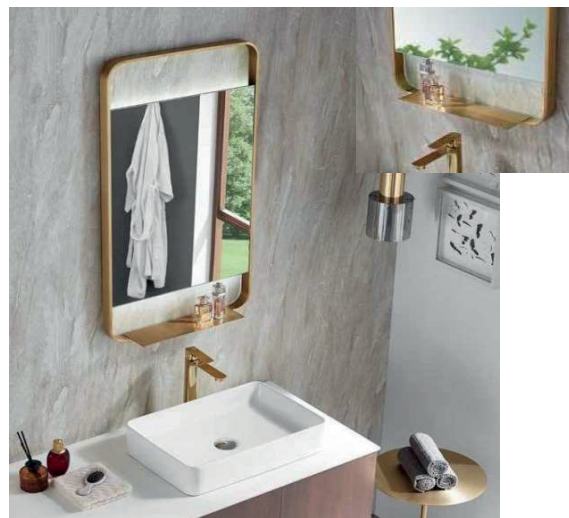

CÓDIGO	MEDIDAS	€
14022444	600x1000	325,00

**WT-046**

PERFIL PRETO

ESPELHO C/ TOUCH + DESEMBACIADOR



CÓDIGO	MEDIDAS	€
14022523	600x800	300,00
14022543	600x1000	312,00

**WT-046**

PERFIL DOURADO

ESPELHO C/ TOUCH + DESEMBACIADOR



CÓDIGO	MEDIDAS	€
14022524	600x800	300,00
14022544	600x1000	312,00

# ESPELHOS LED

**WT-070** PERFIL DOURADO  
ESPELHO C/ TOUCH + DESEMBACIADOR



OURO

CÓDIGO	MEDIDAS	€
14022604	Ø 600	300,00
14022634	Ø 800	315,00

PRETO

CÓDIGO	MEDIDAS	€
14022603	Ø 600	300,00
14022633	Ø 800	315,00

**WT-071** PERFIL PRETO  
ESPELHO C/ TOUCH + DESEMBACIADOR



PRETO

CÓDIGO	MEDIDAS	€
14022743	600x1200	387,00

OURO

CÓDIGO	MEDIDAS	€
14022744	600x1200	387,00

**WT-072** PERFIL DOURADO  
ESPELHO C/ TOUCH + DESEMBACIADOR



OURO

CÓDIGO	MEDIDAS	€
14022844	600x1200	400,00

PRETO

CÓDIGO	MEDIDAS	€
14022843	600x1200	400,00

**WT-076**  
ESPELHO C/ TOUCH + DESEMBACIADOR



CÓDIGO	MEDIDAS	€
A- 14020712	580x600	170,00
B-14020732	740x800	180,00

# ESPELHOS

## LUA

ESPELHO C/ TOUCH + DESEMBACIADOR



CÓDIGO	MEDIDAS	€
14020752	Ø 800	156,00

## SOL C/ ORLA EM MADEIRA

ESPELHO



CÓDIGO	MEDIDAS	€
14010541	600x800	68,00
14010542	800x800	78,00
14010544	1000x80	98,00

## SIDNEY

ESPELHO SIMPLES



CÓDIGO	MEDIDAS	€
14010268	600x500	31,00
14010269	700x500	36,00
14010262	800x600	45,00
14010260	800x800	54,00
14010267	1000x800	70,00

## ALUMINIO

C/REFORÇO DE MADEIRA ORLA COR ALUMINIO



CÓDIGO	MEDIDAS	€
14010232	600x500	34,00
14010233	700x500	37,00
14010234	800x500	40,70
14010235	800x600	44,00
14010236	1000x500	50,00
14010238	1000x600	56,00
14010246	1200x700	65,00
14010248	1200x800	72,00

# ESPELHOS

## ESPELHO C/ ORLA ALUMINUIO



CÓDIGO	MEDIDAS	€
14010371	600x500	42,50
14010372	700x500	47,00
14010373	800x500	52,00
14010383	1000x700	85,00
14010384	1000x800	95,00
14010385	1200x700	105,00
14010386	1200x800	120,00

## ORLADO

ESPELHO COM ORLADO COR DA MADEIRA



CÓDIGO	MEDIDAS	€
14010519	600x500	34,00
14010518	600x600	35,00
14010521	800x500	42,00
14010521	800x600	38,00
14010533	800x800	71,00
14010524	1000x500	56,00
14010536	1000x800	86,00
14010537	1200x800	95,00

## ESTER

APLIQUE



CÓDIGO	MEDIDAS	€
14050160	C/ Luz LED 30 cm	49,00
14050162	C/ Luz LED 40 cm	55,00
14050164	C/ Luz LED 60 cm	62,00



## SEPARADOR

2

- BANHEIRAS DE CENTRO
- MONOCOMANDOS DE BANHEIRA
- BANHEIRAS DE HIDROMASSAGEM
- BASES RESINA
- BASES ACRILICAS



# Bolero



Medida  
170x80

Preço  
1.380,00€

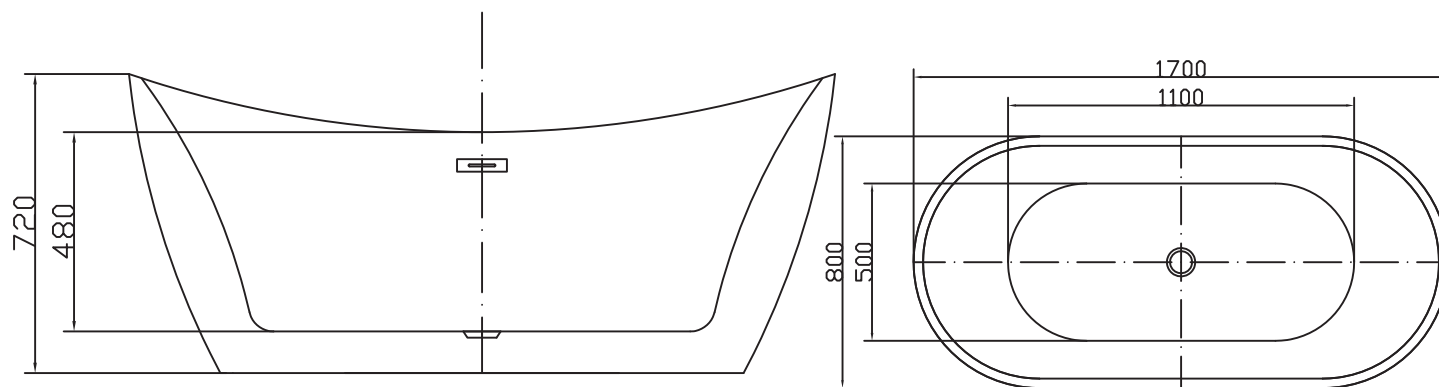

# Lamonde



<u>Medidas</u>	<u>Cor</u>	<u>Preço</u>
170x80	Branco	1.390,00€
180x85	Branco	1.416,00€

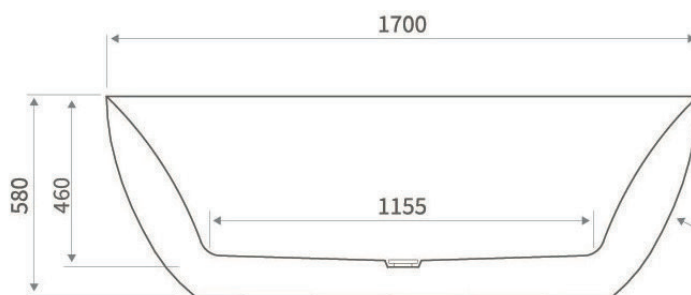
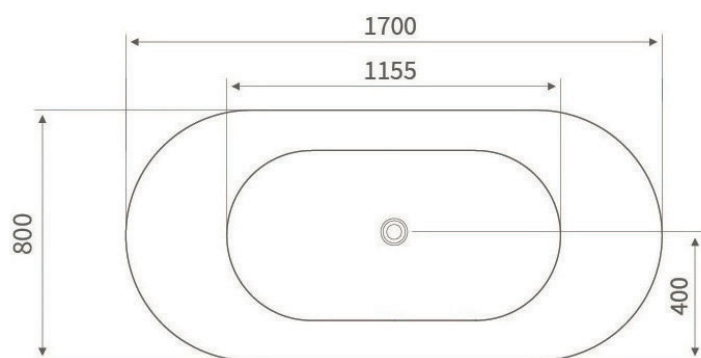

# Lugano



<u>Medidas</u>	<u>Cor</u>	<u>Preço</u>
150x75	Branco	1.260,00€
160x75	Branco	1.360,00€
170x75	Branco	1.380,00€

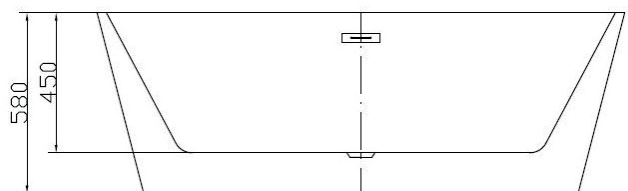
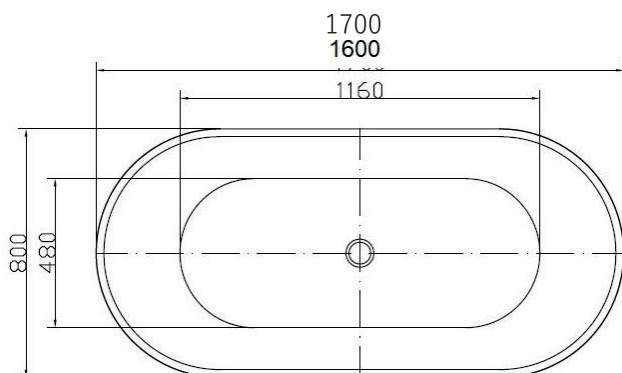

# Maggi



<u>Medidas</u>	<u>Cor</u>	<u>Preço</u>
170x80	Branco	1.380,00€
	Br./Preto	1.410,00€

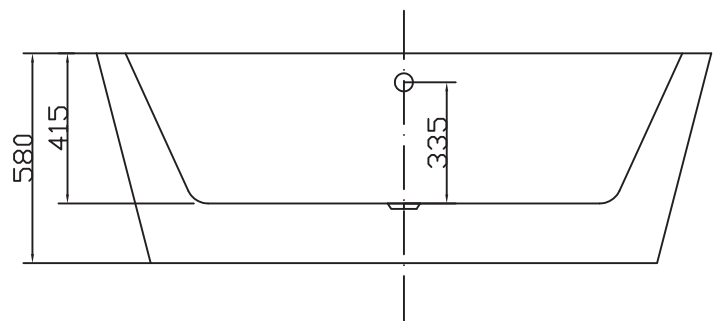
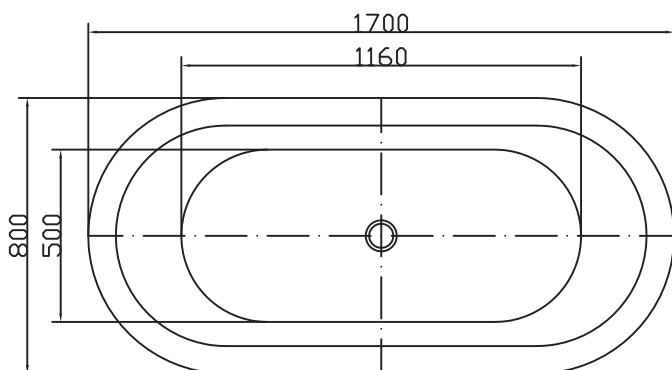

# Saturno



Medidas  
170x80

Preço  
1.390,00€

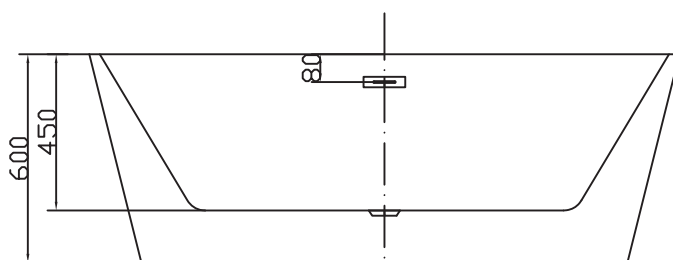
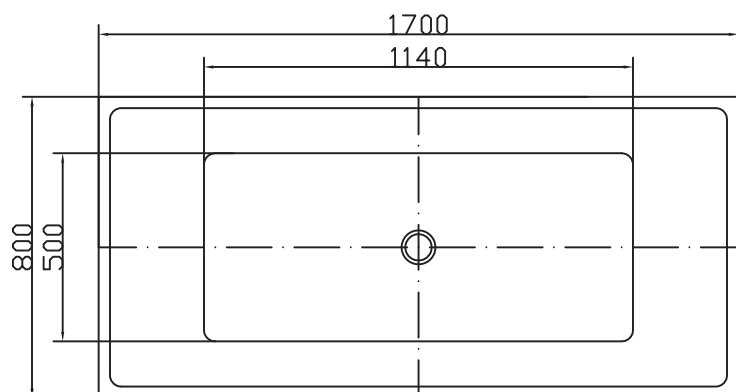

# Piave



Medidas  
170x80

Preço  
1.380,00€

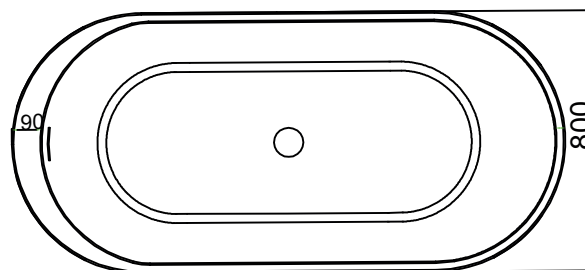
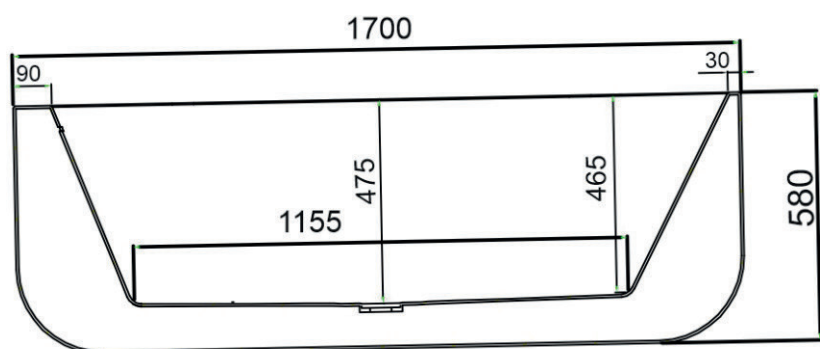

# Reno



Medidas  
170x80

Preço  
1.380,00€

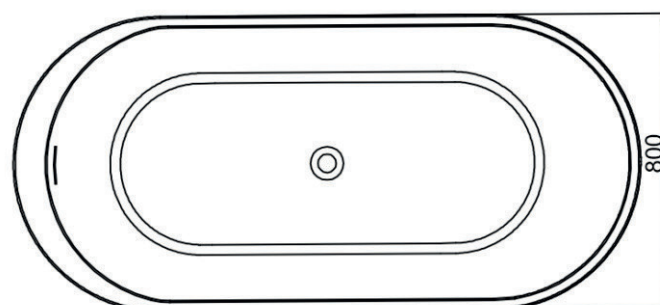
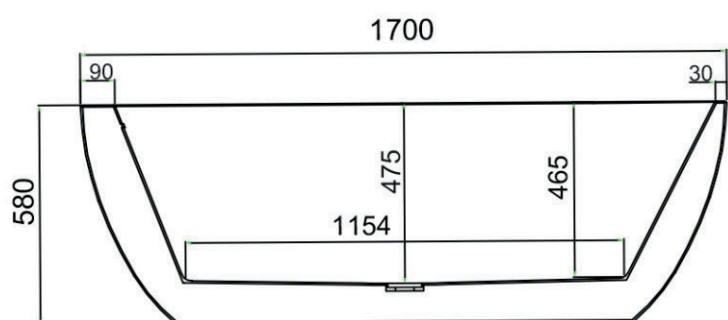

# Savena



Medidas  
168x76

Preço  
1.380,00€

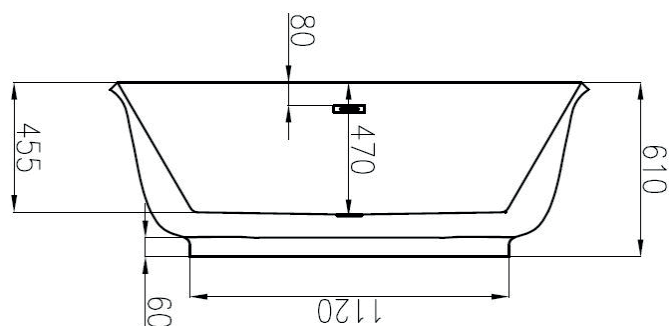
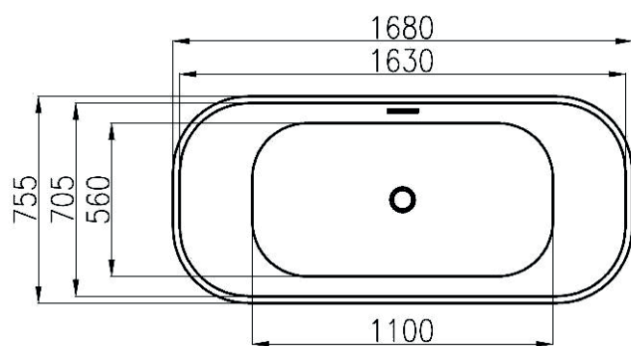

Mod. **San**



Medidas  
180x90

Preço  
1.320,00€

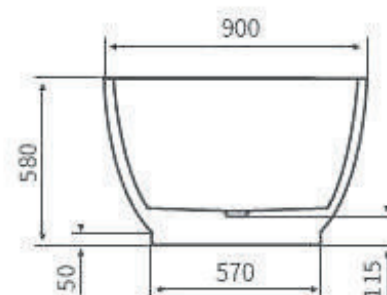
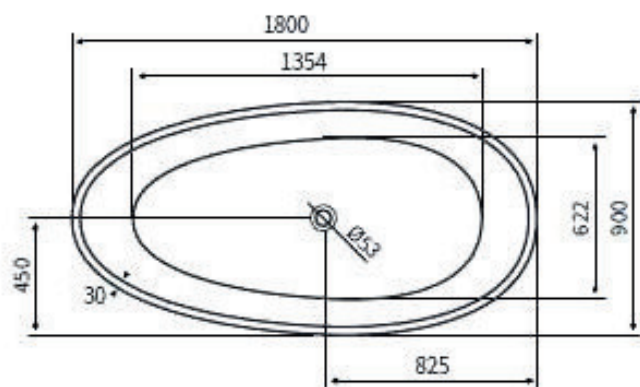

# Balaton



Medidas  
180x90

Preço  
1.320,00€

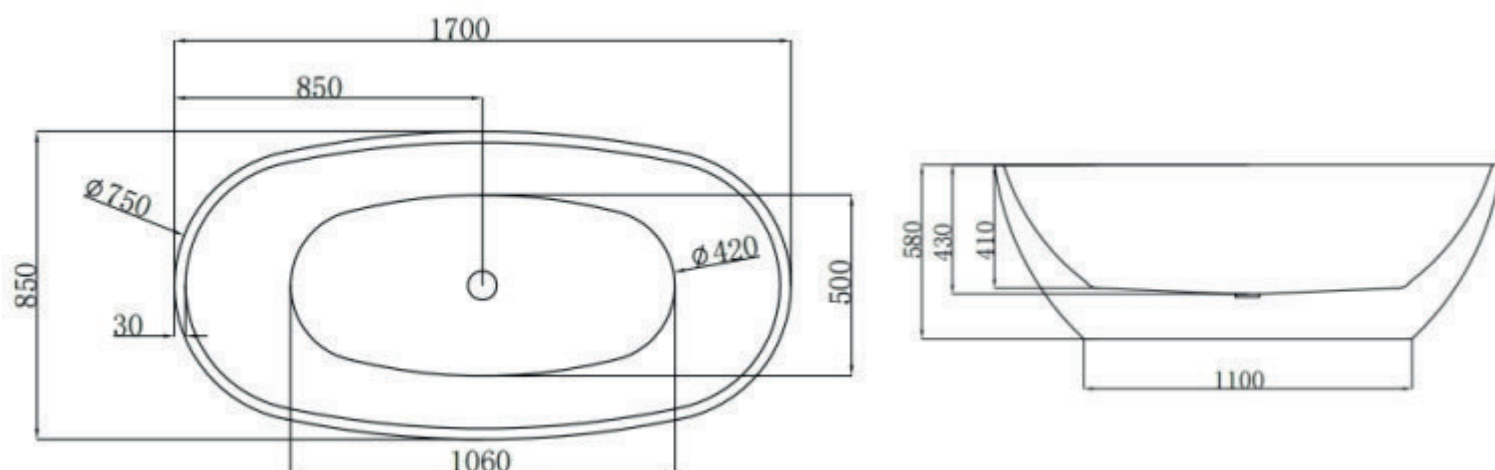

# Balteia



Medidas  
170x80

Preço  
1.280,00€

Avar



Medidas  
170x72

Preço  
1.530,00€

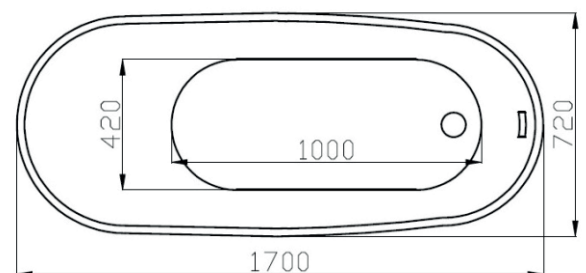
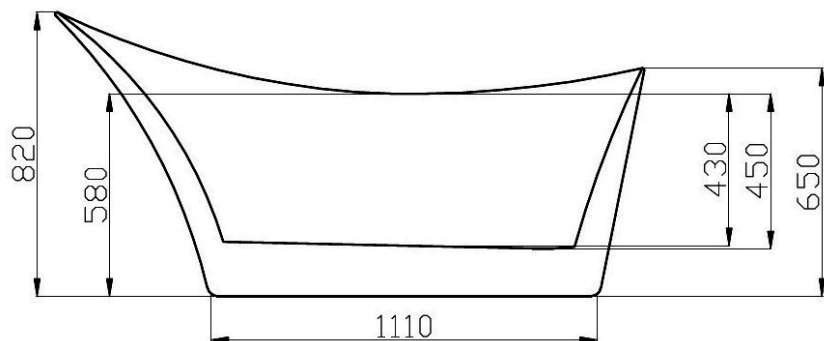

# Cesano



<u>Medidas</u>	<u>Cor</u>	<u>Preço</u>
160x72	Branco	1.335,00€
	Br./Preto	1.445,00€

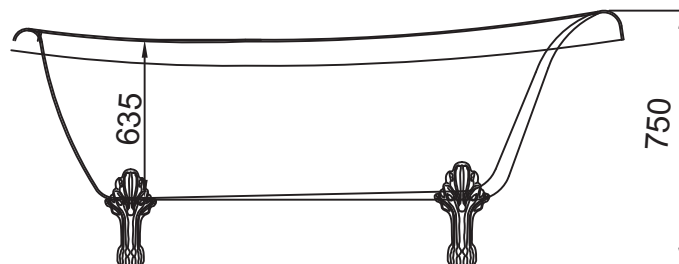
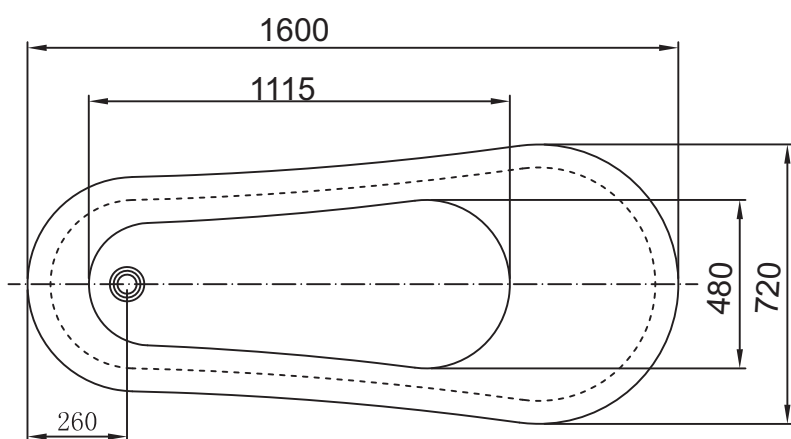

# Tesino



Medidas  
170x77

Preço  
1.335,00€

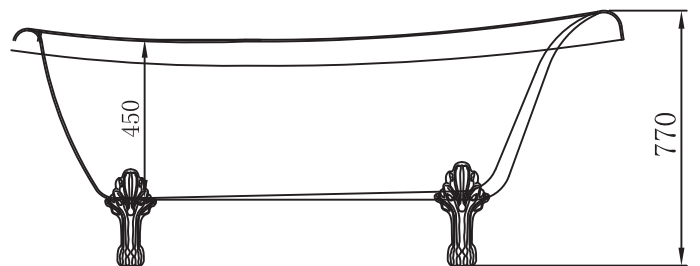
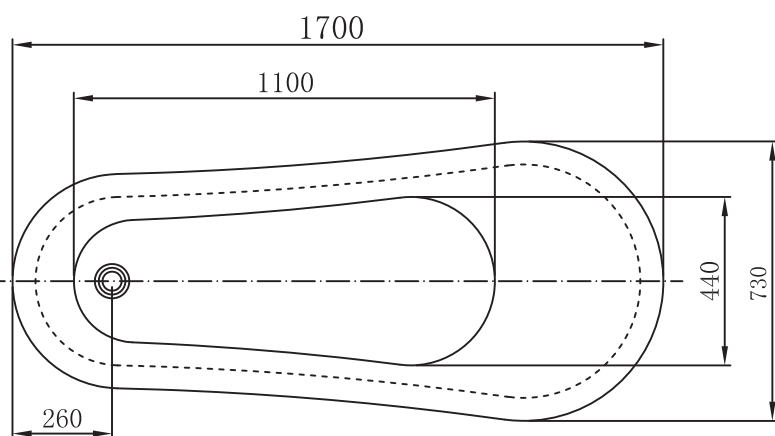

# Tesino



<u>Medidas</u>	<u>Cor</u>	<u>Preço</u>
170x77	Br./Preto	1.445,00€

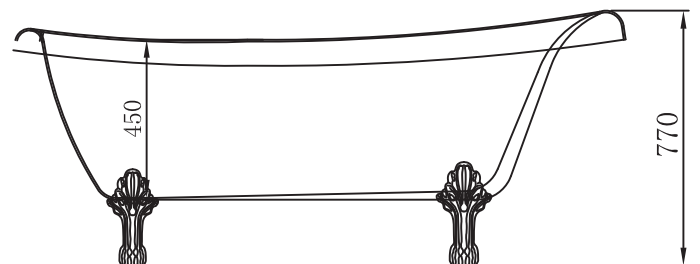
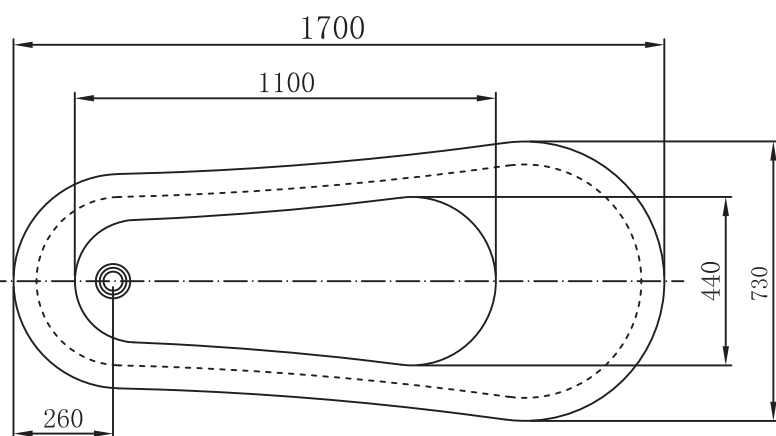

# Torneiras



M-126

520,00€



MH-102

520,00€



M-9102

520,00€



M-9104

520,00€



MH-103

520,00€

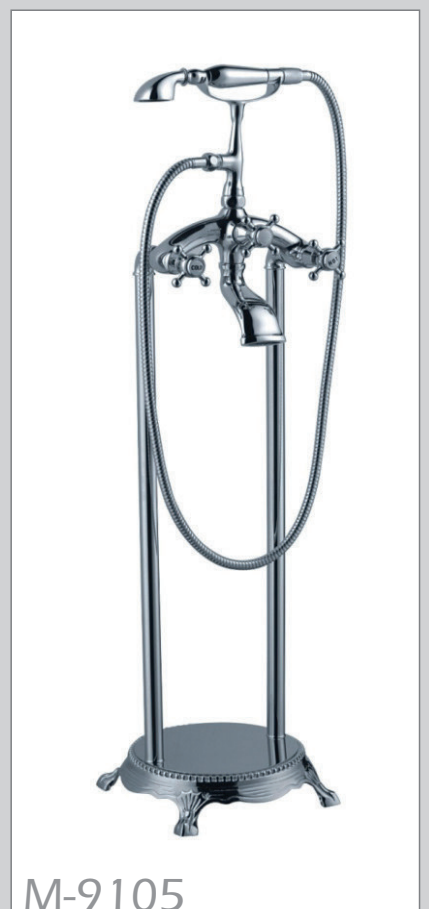

M-9105

540,00€

# BANHEIRAS HIDROMASSAGEM

## RT-1708

BANHEIRA RETANGULAR C/ HIDROMASSAGEM













CÓDIGO

€

09050116

3 120,00

Equipada com:

-  • Comando Digital
-  • Bluetooth
-  • 8 Jactos ar
-  • 10 Jactos laterais circulação água
-  • Ozono
-  • Sistema limpeza tubos
-  • Sistema segurança
-  • Torneira cascata
-  • Encosto cabeça
-  • Aquecimento água

MEDIDAS: 1850x900x680

## RT-1813

BANHEIRA RETANGULAR C/ HIDROMASSAGEM













CÓDIGO

€

09050112

3 295,00

Equipada com:

-  • Comando Digital
-  • Bluetooth
-  • 16 Jactos ar
-  • 10 Jactos laterais circulação água
-  • Ozono
-  • Sistema limpeza tubos
-  • Sistema segurança
-  • Torneira
-  • Encosto cabeça
-  • Aquecimento água

MEDIDAS: 1700x900x600

# BANHEIRAS HIDROMASSAGEM

## XA 068B

BANHEIRA RETANGULAR C/ HIDROMASSAGEM













CÓDIGO

€

09050117

3 500,00

Equipada com:

-  • Comando Digital
-  • Rádio
-  • Jactos bolhas ar
-  • Jactos laterais circulação água
-  • Ozono
-  • Sistema limpeza tubos
-  • Sistema segurança
-  • Torneira
-  • Encosto cabeça
-  • Aquecimento água

MEDIDAS: 1700x800x600

## XA 009

BANHEIRA C/ HIDROMASSAGEM













CÓDIGO

€

09050110

3 500,00

Equipada com:

-  • Comando Digital
-  • Rádio
-  • Jactos bolhas ar
-  • Jactos laterais circulação água
-  • Ozono
-  • Sistema limpeza tubos
-  • Sistema segurança
-  • Cascata
-  • Encosto cabeça
-  • Aquecimento água

MEDIDAS: 1800x1200x600

# BANHEIRAS HIDROMASSAGEM









## IR 1902

BANHEIRA C/ HIDROMASSAGEM



**CÓDIGO** €  
09050122 **3 210,00**

Equipada com:

-  • Comando digital
-  • Bluetooth
-  • Jactos bolhas ar
-  • Jactos laterais circulação água
-  • Ozono
-  • Sistema limpeza tubos
-  • Sistema segurança
-  • Torneira

**MEDIDAS:** 1900x900x670









## XA 108

BANHEIRA C/ HIDROMASSAGEM



**CÓDIGO** €  
09050115 **2 970,00**

Equipada com:

-  • Comando Digital
-  • Rádio
-  • Jactos bolhas ar
-  • Jactos laterais circulação água
-  • Ozono
-  • Sistema limpeza tubos
-  • Sistema segurança
-  • Torneira
-  • Aquecimento água

**MEDIDAS:** 1700x800x600

# BANHEIRAS HIDROMASSAGEM

## XA 021

BANHEIRA RETANGULAR C/ HIDROMASSAGEM











CÓDIGO

€

09050117

3 400,00

Equipada com:

-  • Comando Digital
-  • Rádio
-  • Jactos bolhas ar
-  • Jactos laterais circulação água
-  • Ozono
-  • Sistema limpeza tubos
-  • Sistema segurança
-  • Torneira
-  • Encosto cabeça

MEDIDAS: 1700x800x600

## RT 1809

BANHEIRA RETANGULAR C/ HIDROMASSAGEM











CÓDIGO

€

09050108

3 500,00

Equipada com:

-  • Comando digital
-  • Bluetooth
-  • Jactos bolhas ar
-  • Jactos laterais circulação água
-  • Ozono
-  • Sistema limpeza tubos
-  • Sistema segurança
-  • Torneira
-  • Encosto cabeça

MEDIDAS: 1850x1200x600

# BANHEIRAS HIDROMASSAGEM

## RT 1804

BANHEIRA RETANGULAR C/ HIDROMASSAGEM











CÓDIGO

€

09050127

2 920,00

Equipada com:

-  • Comando digital
-  • Bluetooth
-  • Jactos bolhas ar
-  • Jactos laterais circulação água
-  • Ozono
-  • Sistema limpeza tubos
-  • Sistema segurança
-  • Torneira
-  • Encosto cabeça

MEDIDAS: 1800x900x600

## RT 1806

BANHEIRA RETANGULAR C/ HIDROMASSAGEM













CÓDIGO

€

09050130

3 500,00

Equipada com:

-  • Comando digital
-  • Bluetooth
-  • Jactos bolhas ar
-  • Jactos laterais circulação água
-  • Ozono
-  • Sistema limpeza tubos
-  • Sistema segurança
-  • Torneira
-  • Encosto cabeça
-  • Aquecimento água

MEDIDAS: 1800x1415x740

# BANHEIRAS HIDROMASSAGEM











## NR 1502

BANHEIRA DE CANTO C/ HIDROMASSAGEM



CÓDIGO	€
09050133	3 000,00

Equipada com:

-  • Comando
-  • Bluetooth
-  • Jactos bolhas ar
-  • Jactos laterais circulação água
-  • Ozono
-  • Sistema limpeza tubos
-  • Sistema segurança
-  • Torneira com cascata
-  • Encosto cabeça
-  • Aquecimento água

**MEDIDAS:** 1500x1500x610











## NR 1601

BANHEIRA DE CANTO C/ HIDROMASSAGEM



CÓDIGO	€
09050135	3 000,00

Equipada com:

-  • Comando
-  • Bluetooth
-  • Jactos bolhas ar
-  • Jactos laterais circulação água
-  • Ozono
-  • Sistema limpeza tubos
-  • Sistema segurança
-  • Torneira com cascata
-  • Encosto cabeça
-  • Aquecimento água

**MEDIDAS:** 1600x1600x680

## BANHEIRAS SIMPLES C/ HIDROMASSAGEM

### CHARME 140X140

BANHEIRA DE CANTO



CODIGO	SISTEMA	€
09015515	ECOLINE	<b>1 628,00</b>
09015516	DUPLO ELÉTRICO	<b>2 730,00</b>
09015514	SIMPLES	<b>615,00</b>
09015519	PAINEL FT	<b>350,00</b>

### CHARME 180X180

BANHEIRA RETANGULAR



CODIGO	SISTEMA	€
09015350	ECOLINE 6 JATOS	<b>1 190,00</b>
09015355	DUPLO ELÉTRICO	<b>2 280,00</b>
09015136	SIMPLES	<b>270,00</b>
09015520	PAINEL FT	<b>160,00</b>
09015521	PAINEL LT	<b>110,00</b>
09015061	PÉS APOIO	<b>30,00</b>

### CLASSICA 170X75

BANHEIRA RETANGULAR



CODIGO	SISTEMA	€
09015361	ECOLINE	<b>1 184,00</b>
09015363	DUPLO ELÉTRICO	<b>2 280,00</b>
09015137	SIMPLES	<b>280,00</b>
09015524	PAINEL FT	<b>140,00</b>
09015525	PAINEL LT	<b>96,00</b>
09015059	PÉS APOIO	<b>30,00</b>

*Outros Modelos e Medidas, por favor consultar.*

# BASE CHUVEIRO RESINA

## Mod. Elite



Largura	Comprimento													
	80	90	100	110	120	130	140	150	160	170	180	190	200	210
70	184 €	206 €	229 €	252 €	275 €	298 €	321 €	344 €	367 €	390 €	412 €	435 €	458 €	481 €
80	210 €	236 €	262 €	288 €	314 €	340 €	367 €	393 €	419 €	445 €	471 €	497 €	524 €	550 €
90	•	265 €	295 €	324 €	354 €	383 €	412 €	442 €	471 €	501 €	530 €	560 €	589 €	618 €
100	•	295 €	327 €	360 €	393 €	425 €	458 €	491 €	524 €	556 €	589 €	622 €	654 €	687 €

### Cores Standard



Preto



Grafite



Creme



Branco

### Características

- Base de duche de resina com carga mineral acabamento em gel coat textura tipo ardósia
- Espessura + - 3,00 cm
- Antiderrapante
- Grelha decorativa inox e valvula incluídas

# BASE CHUVEIRO RESINA

## Mod. ELITE GRELHA OCULTA



Largura	Comprimento													
	80	90	100	110	120	130	140	150	160	170	180	190	200	210
70	196 €	221 €	245 €	270 €	294 €	319 €	343 €	368 €	392 €	417 €	441 €	466 €	490 €	514 €
80	224 €	252 €	280 €	308 €	336 €	364 €	392 €	420 €	448 €	476 €	504 €	532 €	560 €	588 €
90	•	284 €	315 €	347 €	378 €	410 €	441 €	473 €	504 €	536 €	567 €	599 €	630 €	662 €
100	•	315 €	350 €	385 €	420 €	455 €	490 €	525 €	560 €	595 €	630 €	665 €	700 €	735 €

### Cores Standard



Preto



Grafite



Creme



Branco

### Características

- Base de duche de resina com carga mineral acabamento em gel coat textura tipo ardósia
- Espessura + - 3,00 cm
- Antiderrapante
- Grelha decorativa cor e valvula incluídas

# BASE CHUVEIRO RESINA

## Mod. NEO



Largura	Comprimento													
	80	90	100	110	120	130	140	150	160	170	180	190	200	210
70	196 €	221 €	245 €	270 €	294 €	319 €	343 €	368 €	392 €	417 €	441 €	466 €	490 €	514 €
80	224 €	252 €	280 €	308 €	336 €	364 €	392 €	420 €	448 €	476 €	504 €	532 €	560 €	588 €
90	•	284 €	315 €	347 €	378 €	410 €	441 €	473 €	504 €	536 €	567 €	599 €	630 €	662 €
100	•	315 €	350 €	385 €	420 €	455 €	490 €	525 €	560 €	595 €	630 €	665 €	700 €	735 €

### Cores Standard



Preto



Grafite



Creme



Branco

### Características

- Base de duche de resina com carga mineral acabamento em gel coat textura tipo ardósia
- Espessura + - 3,00 cm
- Antiderrapante
- Grelha decorativa cor e valvula incluídas

# BASE RESINA CARGA MINERAL

## Mod. Plan



Largura	Comprimento																
	80	90	100	110	120	130	140	150	160	170	180	190	200	210	220	230	240
70	177 €	190 €	204 €	217 €	230 €	243 €	256 €	269 €	282 €	295 €	308 €	321 €	335 €	348 €	680 €	1 080 €	1 100 €
75	•	•	245 €	261 €	278 €	294 €	311 €	327 €	344 €	360 €	377 €	393 €	410 €	426 €	754 €	•	•
80	203 €	207 €	222 €	237 €	252 €	267 €	282 €	297 €	312 €	327 €	342 €	357 €	372 €	387 €	685 €	1 090 €	1 120 €
90	•	217 €	241 €	258 €	275 €	292 €	308 €	325 €	342 €	359 €	376 €	393 €	409 €	426 €	750 €	1 100 €	1 160 €
100	•	241 €	268 €	278 €	297 €	316 €	335 €	353 €	372 €	371 €	409 €	428 €	447 €	466 €	950 €	•	•
120	CONSULTA			•	•	•	•	•	•	•	•	•	•	•	•	•	•

### Cores Standard



Preto



Grafite



Creme



Branco

» Medida disponível até 2,50Mt. Sobre consulta

» Outras cores e textura sobre consulta

### Características

- Base de duche de resina com carga mineral acabamento em gel coat textura tipo ardósia
- Espessura + - 3,00 cm
- Antiderrapante
- Grelha decorativa inox e valvula incluídas

# BASE CHUVEIRO SMC

## Mod. Gemeas



### Comprimento

Largura	80	90	100	110	120	130	140	150	160	170	180	190	200
70	•	125 €	133 €	141 €	150 €	•	184 €	193 €	205 €	217 €	•	•	345 €
80	125 €	•	147 €	165 €	175 €	196 €	200 €	205 €	213 €	221 €	234 €	312 €	350 €
90	•	150 €	•	•	182 €	•	213 €	•	238 €	250 €	263 €	362 €	•

• Válvula A491ESP = 12,50 €

» Preços válidos para cor "BRANCO".

» Preços para cor "PRETO" - *sob consulta*.

» Medidas de 190 e 200 Grelha ao centro

### Características

- Base de duche **SMC** composto com textura tipo ardósia, material de alta resistência e leve.
- Altura +/- 3 cm
- Antiderrapante
- Grelha decorativa com mesmo acabamento da base.
- Válvula não incluída.

# BASES CHUVEIRO ACRILICAS

BASE CHUVEIRO QUADRADA (Alt. 5cm)

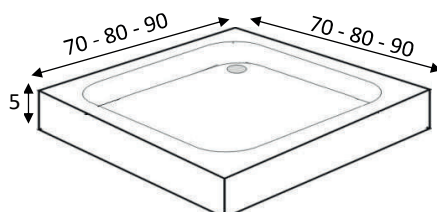

CODIGO	MED.	€
09021011	80x80	114,10
09021021	90x90	116,40

BASE CHUVEIRO CIRCULAR EXTRAPLANA (Alt. 5cm)

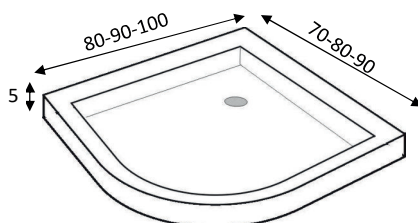

CODIGO	MED.	€
09020211	80x80	116,00
09020221	90x90	123,00

BASE CHUVEIRO RECTANGULAR EXTRAPLANA (Alt. 5cm)

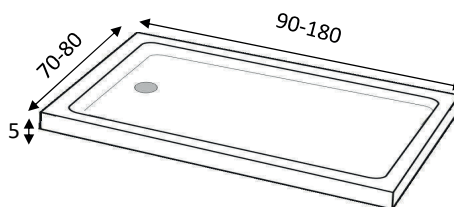

CODIGO	MED.	€
09021051	90x70	117,00
09021071	90x80	122,00
09021081	100x70	123,00
09021101	100x80	124,30
09021121	110x70	124,00
09021141	110x80	138,50
09021161	120x70	142,30
09021181	120x80	146,60
09021185	120x90	154,70
09021191	130x70	164,60
09021211	130x80	171,90
09021221	140x70	172,00
09021241	140x80	191,00
09021251	140x90	218,00
09021261	150x70	203,90
09021281	150x80	219,30
09021311	160x70	220,00
09021331	160x80	226,90
09021341	160x90	235,00
09021351	170x70	235,80
09021371	170x80	245,00
09021381	180x70	247,00
09021391	180x80	257,70



# SEPARADOR

## 3

- RESGUARDOS DE CHUVEIRO
- RESGUARDOS DE BANHEIRA
- CABINES DE HIDROMASSAGEM
- COLUNAS DE HIDROMASSAGEM
- CARRETOS
- SUPORTES P/ RESGUARDO



## RESGUARDOS DE DUCHE



### RA207

RESGUARDO DUCHE 2 FIXOS 2 PORTAS CORRER

Alt. 1950

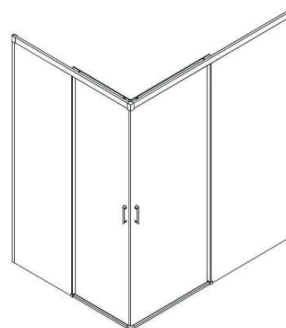

- Vidro **6mm** espessura
- Transparente
- 2 Vidros Fixos 2 Portas de Correr
- Abertura esquina
- Ajustável 2 cm
- Perfil Cromo
- Sem Perfil inferior

CÓDIGO	MED.	€
11020523	800x800	<b>330,00</b>
11020524	900x900	<b>355,00</b>
11020527	1000x700	<b>364,00</b>
11020528	1000x800	<b>374,00</b>
11020530	1200x700	<b>385,00</b>
11020532	1200x800	<b>395,00</b>
11020533	1200x900	<b>410,00</b>
11020538	1400x70	<b>420,00</b>
11020539	1400x80	<b>435,00</b>



### WE-13 + LATERAL FIXO

RESGUARDO DUCHE 1 FIXO 1 PORTA CORRER + LATERAL FIXO

Alt. 1950

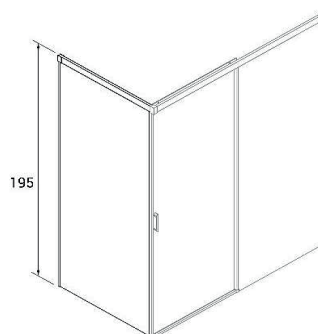

- Vidro **6mm** espessura
- Transparente
- 1 Vidro Fixo 1 Portas de Correr
- Lateral fixo
- Ajustável 2 cm
- Perfil Cromo
- Sem Perfil inferior

FRONTAL		
CÓDIGO	MED.	€
11021547	980-1000	<b>310,00</b>
11021549	1070-1110	<b>315,00</b>
11021550	1120-1160	<b>320,00</b>
11021551	1170-1210	<b>325,00</b>
11021552	1220-1260	<b>330,00</b>
11021553	1270-1310	<b>345,00</b>
11021554	1320-1360	<b>340,00</b>
11021555	1370-1410	<b>395,00</b>
11021557	1420-1460	<b>350,00</b>
11021556	1470-1510	<b>355,00</b>
11021558	1520-1560	<b>360,00</b>
11021559	1570-1610	<b>365,00</b>

LATERAL FIXO		
CÓDIGO	MED.	€
11021568	680-700	<b>168,00</b>
11021569	780-800	<b>172,00</b>
11021570	880-900	<b>177,00</b>

## RESGUARDOS DE DUCHE



### IZA - perfil preto

RESGUARDO DUCHE 2 FIXOS 2 PORTAS CORRER

Alt. 1950

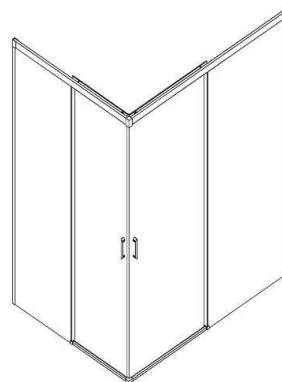

CÓDIGO	MED.	€
11022202	800x800	655,00
11022203	900x900	707,00
11022204	1000x700	668,00
11022205	1000x800	687,00
11022206	1200x700	740,00
11022207	1200x800	760,00
11022208	1200x900	785,00
11022209	1400x800	803,00
11022210	1400x900	828,00

- Vidro **6mm** espessura
- Transparente
- 2 Vidros Fixos 2 Portas de Correr
- Abertura esquina
- Ajustável 2 cm
- **Perfil Preto**
- Sem Perfil inferior



### IZA 2 + LATERAL FIXO - perfil preto

RESGUARDO DUCHE 1 FIXO 1 PORTA CORRER + LATERAL FIXO

Alt. 1950

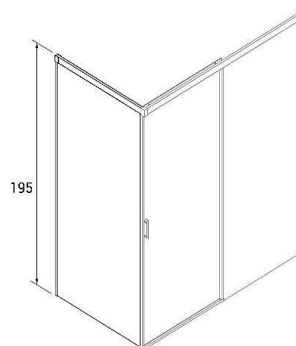

FRONTAL		
CÓDIGO	MED.	€
11022225	1150-1200	430,00
11022226	1200-1250	443,00
11022227	1250-1300	456,00
11022228	1300-1350	470,00
11022229	1350-1400	475,00
11022230	1400-1450	500,00
11022231	1450-1500	510,00
11022232	1500-1550	520,00
11022233	1550-1600	540,00

- Vidro **6mm** espessura
- Transparente
- 1 Vidro Fixo 1 Portas de Correr
- Lateral fixo
- Ajustável 2 cm
- **Perfil Preto**
- Sem Perfil inferior

LATERAL FIXO		
CÓDIGO	MED.	€
11022241	680-700	238,00
11022243	780-800	264,00
11022244	880-900	289,00

## RESGUARDOS DE DUCHE



### RFA801 + LATERAL FIXO

RESGUARDO DUCHE 1 FIXO 1 PORTA CORRER

Alt. 1950

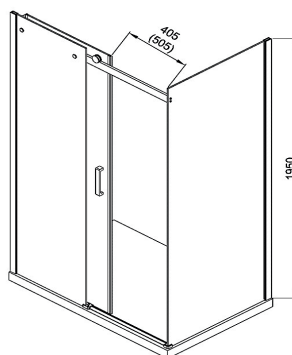

- Vidro **8mm** espessura
- Transparente
- 1 Vidro Fixo 1 Porta de Correr
- Sem Perfil inferior
- Ajustável 2 cm
- Lateral Fixo
- Perfil Superior Cromo

#### FRONTAL

CÓDIGO	MED.	€
11021396	980-1000	430,00
11021398	1080-1100	435,00
11021399	1130-1150	441,00
11021401	1180-1200	447,00
11021402	1230-1250	452,00
11021403	1280-1300	457,00
11021404	1330-1350	469,00
11021405	1380-1400	480,00
11021406	1430-1450	494,00
11021407	1480-1500	500,00
11021408	1530-1550	509,00
11021409	1580-1600	515,00
11021410	1630-1650	523,00
11021411	1680-1700	530,00
11021412	1730-1750	550,00
11021413	1780-1800	600,00

#### LATERAL FIXO - RFA

CÓDIGO	MED.	€
11021431	680-700	225,00
11021433	780-800	231,00
11021434	880-900	236,00



### R1520 + LATERAL FIXO

RESGUARDO DUCHE 1 FIXO 1 PORTA CORRER

Alt. 1950

- Vidro **8mm** espessura
- Transparente
- 1 Vidro Fixo 1 Porta de Correr
- Sem Perfil inferior
- Carrtos ocultos
- Perfil cromo
- Lateral Fixo

#### FRONTAL

CÓDIGO	MED.	€
11022005	1180-1200	447,00
11022006	1230-1250	452,00
11022007	1280-1300	457,00
11022009	1380-1400	480,00
11022011	1480-1500	500,00
11022013	1580-1600	515,00
11022014	1630-1650	523,00
11022015	1680-1700	530,00
11022016	1730-1750	550,00
11022017	1780-1800	600,00

#### LATERAL FIXO - R1520

CÓDIGO	MED.	€
11022022	680-700	225,00
11022023	780-800	231,00
11022024	880-900	236,00

## RESGUARDOS DE DUCHE



### RJU136

RESGUARDO DUCHE 1 FIXO 1 PORTA CORRER + LATERAL FIXO

Alt. 1950

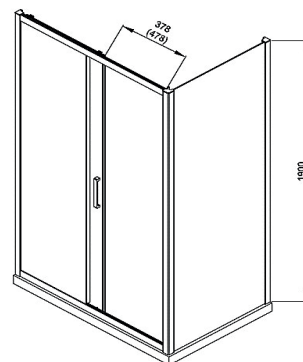

CÓDIGO	MED.	€
11020763	1000x800	<b>450,00</b>
11020766	1200x800	<b>465,00</b>

- Vidro **6mm** espessura
- Transparente
- 1 Vidro Fixo 1 Porta de Correr
- Lateral Fixo
- Ajustável 2 cm
- Perfil Cromo



### MANHATTAN + LATERAL FIXO

RESGUARDO DUCHE 1 FIXO 1 PORTA CORRER

Alt. 1950

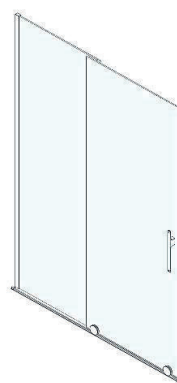

CÓDIGO	MED.	€
11021252	1170-1220	<b>442,00</b>
11021253	1220-1270	<b>452,00</b>
11021254	1270-1320	<b>457,00</b>
11021255	1320-1370	<b>469,00</b>
11021256	1370-1420	<b>480,00</b>
11021257	1420-1470	<b>494,00</b>
11021258	1470-1520	<b>500,00</b>
11021259	1520-1570	<b>509,00</b>
11021260	1570-1620	<b>515,00</b>
11021261	1620-1670	<b>523,00</b>
11021262	1670-1720	<b>528,00</b>
11021263	1720-1770	<b>537,00</b>
11021264	1770-1820	<b>555,00</b>
11021265	1820-1870	<b>570,00</b>
11021266	1870-1920	<b>595,00</b>

- Vidro **8mm** espessura
- Transparente
- 1 Vidro Fixo 1 Porta de Correr
- Sem Perfil superior
- Ajustável 2 cm
- Lateral fixo
- Perfil cromo

#### LATERAL FIXO - MANHATTAN

CÓDIGO	MED.	€
11020395	680-700	<b>225,00</b>
11020397	780-800	<b>231,00</b>
11020398	880-900	<b>236,00</b>

## RESGUARDOS DE DUCHE



### RJBC146

RESGUARDO DUCHE 2 FIXOS 2 PORTAS CORRER

Alt. 1950



- Vidro **6mm** espessura
- Vidro Transparente
- 2 Vidros Fixos 2 Portas de Correr
- Ajustável 2 cm
- Carretos metalicos cromados
- Carretos inferiores ajustaveis
- Perfil cromo

CÓDIGO	MED.	€
11020589	700x700	<b>305,00</b>
11020590	800x800	<b>311,00</b>
11020591	900x900	<b>332,00</b>
11020592	1000x700	<b>345,00</b>
11020593	1000x800	<b>347,00</b>
11020594	1200x700	<b>365,00</b>
11020595	1200x800	<b>368,00</b>
11020596	1200x900	<b>375,00</b>
11020597	1400x700	<b>385,00</b>
11020598	1400x800	<b>389,00</b>
11020599	1400x900	<b>399,00</b>



### RJBC146 - perfil preto

RESGUARDO DUCHE 2 FIXOS 2 PORTAS CORRER

Alt. 1950

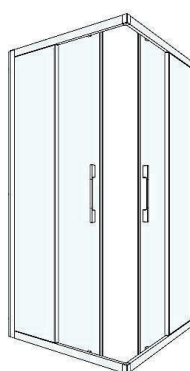

- vidro **6mm** espessura
- Vidro Transparente
- 2 Vidros Fixos 2 Portas de Correr
- Ajustável 2 cm
- Carretos metalicos cromados
- Carretos inferiores ajustaveis
- Perfil Preto

CÓDIGO	MED.	€
11020589PRT	700x700	<b>642,00</b>
11020590PRT	800x800	<b>690,00</b>
11020591PRT	900x900	<b>739,00</b>
11020592PRT	1000x700	<b>703,00</b>
11020593PRT	1000x800	<b>727,00</b>
11020594PRT	1200x700	<b>750,00</b>
11020595PRT	1200x800	<b>774,00</b>
11020596PRT	1200x900	<b>798,00</b>
11020597PRT	1400x700	<b>810,00</b>
11020598PRT	1400x800	<b>835,00</b>
11020599PRT	1400x900	<b>856,00</b>

## RESGUARDOS DE DUCHE



### RJM126B

RESGUARDO DUCHE 2 PORTAS ABRIR

Alt. 1950

CÓDIGO	MED.	€
11020292	800x800	613,00
11020293	900x900	631,00

- Vidro **6mm** espessura
- Vidro transparente
- 2 Portas de Abrir
- Ajustável 2 cm
- Perfil cromo



### RJD126

RESGUARDO DUCHE 1 FIXO 1 PORTA ABRIR

Alt. 1950

CÓDIGO	A MED. B	€
11020414	800x800	487,00
11020415	900x900	510,00
11020416	900x800	496,00
11020417	1000x800	510,00
11020418	1000x900	516,00
11020419	1200x800	550,00
11020420	1200x900	570,00

- Vidro **6mm** espessura
- Vidro Transparente
- 1 Vidro Fixo
- 1 Porta de abrir
- Perfil cromo
- Braço incluído

## RESGUARDOS DE DUCHE



### RJAB145

RESGUARDO DUCHE 2 FIXOS 2 PORTAS CORRER

Alt. 1900

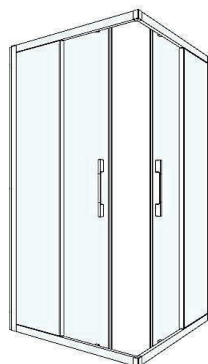

- Vidro **5mm** espessura
- Vidro Transparente
- 2 Vidros Fixos 2 Portas de Correr
- Ajustável 2 cm
- Carretos metalicos cromados
- Carretos inferiores ajustaveis
- Perfil cromo

CÓDIGO	MED.	€
11020215	700x700	<b>235,00</b>
11020216	800x800	<b>237,00</b>
11020217	900x900	<b>248,00</b>
11020220	1000x700	<b>256,00</b>
11020219	1000x800	<b>258,00</b>
11020222	1200x700	<b>267,00</b>
11020221	1200x800	<b>273,00</b>



### RJAB245

RESGUARDO DUCHE 2 FIXOS 2 PORTAS CORRER

Alt. 1900

- Vidro **5mm** espessura
- Vidro Transparente
- 2 Vidros Fixos 2 Portas de Correr
- Ajustável 2 cm
- Carretos metalicos cromados
- Carretos inferiores ajustaveis
- Perfil cromo

CÓDIGO	MED.	€
11020233	800x800	<b>261,00</b>
11020234	900x900	<b>275,00</b>

## RESGUARDOS DE DUCHE FRONTAIS



### RFA801

RESGUARDO DUCHE 1 FIXO 1 PORTA CORRER

Alt. 1950

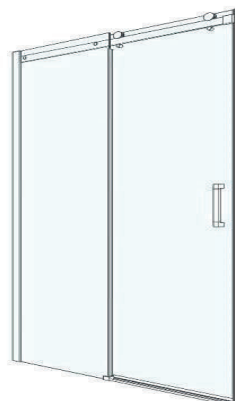

- Vidro **8mm** transparente
- Perfil superior cromo
- S/ perfil inferior
- Puxador metálico cromo
- Montagem reversível

CÓDIGO	MEDIDA	€
11021396	980-1000	<b>430,00</b>
11021398	1080-1100	<b>435,00</b>
11021399	1130-1150	<b>441,00</b>
11021401	1180-1200	<b>447,00</b>
11021402	1230-1250	<b>452,00</b>
11021403	1280-1300	<b>457,00</b>
11021404	1330-1350	<b>469,00</b>
11021405	1380-1400	<b>480,00</b>
11021406	1430-1450	<b>494,00</b>
11021407	1480-1500	<b>500,00</b>
11021408	1530-1550	<b>509,00</b>
11021409	1580-1600	<b>515,00</b>
11021410	1630-1650	<b>523,00</b>
11021411	1680-1700	<b>530,00</b>
11021412	1730-1750	<b>550,00</b>
11021413	1780-1800	<b>600,00</b>



### RFA803

RESGUARDO DUCHE 2 FIXOS 2 PORTAS DE CORRER

Alt. 1950

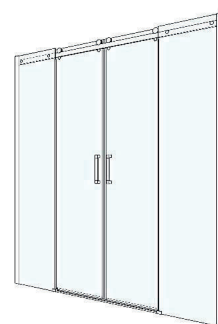

- Vidro **8mm** transparente
- Perfil superior cromo
- S/ perfil inferior
- Puxador metálico cromo
- Montagem reversível

CÓDIGO	MEDIDA	€
11021420	1580-1600	<b>645,00</b>
11021422	1680-1700	<b>652,00</b>
11021423	1730-1750	<b>658,00</b>
11021424	1780-1800	<b>660,00</b>
11021425	1830-1850	<b>669,00</b>
11021426	1880-1900	<b>680,00</b>
11021427	1930-1950	<b>690,00</b>

## RESGUARDOS DE DUCHE FRONTAIS



### MANHATTAN

RESGUARDO DUCHE 1 FIXO 1 PORTA CORRER

Alt. 1950

- Vidro 8mm transparente
- Braço incluído
- 1 Vidro Fixo 1 Porta de Correr
- Perfil inferior cromo

CÓDIGO	MEDIDA	€
11021252	1170-1220	442,00
11021253	1220-1270	452,00
11021254	1270-1320	457,00
11021255	1320-1370	469,00
11021256	1370-1420	480,00
11021257	1420-1470	494,00
11021258	1470-1520	500,00
11021259	1520-1570	509,00
11021260	1570-1620	515,00
11021261	1620-1670	523,00
11021262	1670-1720	528,00
11021263	1720-1770	537,00
11021264	1770-1820	555,00
11021265	1820-1870	570,00
11021266	1870-1920	595,00

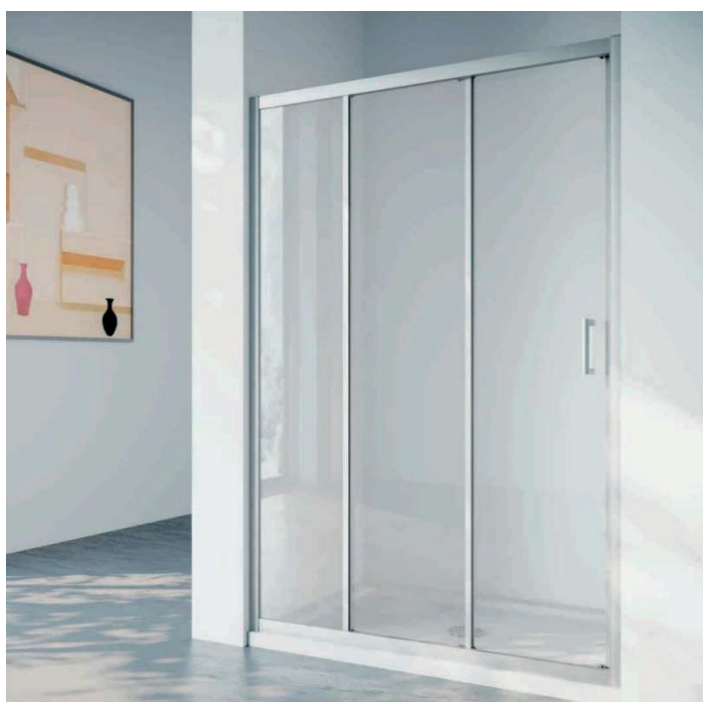

### RJU635

RESGUARDO DUCHE 1 FIXO 2 PORTAS CORRER

Alt. 1900

- Vidro 5mm transparente
- 1 Vidro Fixo 2 Portas de Correr
- Perfil cromo

CÓDIGO	MEDIDA	€
11021439	970-1010	380,00
11021440	1010-1050	386,00
11021441	1060-1100	392,00
11021442	1110-1150	400,00
11021443	1160-1200	415,00
11021444	1210-1250	420,00
11021445	1260-1300	426,00
11021446	1310-1350	432,00
11021447	1360-1400	450,00

## RESGUARDOS DE DUCHE FRONTAIS



### RJU624

RESGUARDO DUCHE ABERTURA TIPO FOLE

Alt. 1950



CÓDIGO	MEDIDA	€
11020745	680-700	360,00
11020746	730-750	370,00
11020747	780-800	377,00
11020748	830-850	385,00
11020749	880-900	396,00
11020206	930-950	412,00
11020207	980-1000	460,00

- Vidro 4mm transparente
- Portas Tipo Fole
- Perfil cromo



### RJUX626

RESGUARDO DUCHE 1 FIXO 1 PORTA CORRER

Alt. 1950

#### FRONTAL

CÓDIGO	MEDIDA	€
11021849	960-1000	270,00
11021850	1010-1050	275,00
11021851	1060-1110	280,00
11021852	1110-1150	285,00
11021853	1160-1200	290,00
11021854	1210-1250	290,00
11021855	1260-1300	300,00
11021856	1310-1350	305,00
11021857	1360-1400	315,00
11021858	1410-1450	325,00
11021859	1460-1500	330,00
11021860	1510-1550	335,00
11021861	1560-1600	340,00
11021862	1660-1650	350,00
11021863	1660-1700	360,00
11021864	1710-1750	375,00
11021865	1760-1800	385,00

- Vidro 6mm transparente
- Perfil cromo
- Carretos ocultos

#### LATERAL FIXO - RJU 616-3

11021842	660 - 700	190,00
11021843	710 - 750	200,00
11021844	760 - 800	215,00
11021846	860 - 900	237,00

## RESGUARDOS DE DUCHE FRONTAIS



### RJBC626

RESGUARDO DUCHE 1 FIXO 1 PORTA CORRER

Alt. 1950

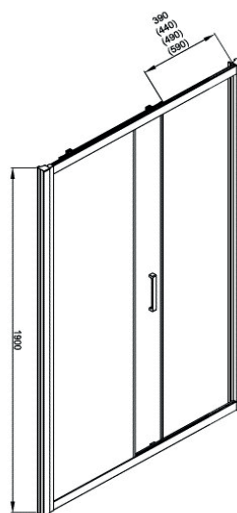

- Vidro 6mm transparente
- 1 Vidro Fixo 1 Porta de correr
- Reversível
- Perfil Cromo

CÓDIGO	MEDIDA	€
11021903	1070-1110	275,00
11021904	1120-1150	280,00
11021905	1170-1210	285,00
11021906	1200-1250	290,00
11021907	1250-1300	298,00
11021908	1300-1350	310,00
11021909	1350-1400	315,00
11021910	1400-1450	320,00
11021911	1450-1500	325,00
11021912	1500-1550	330,00
11021913	1550-1600	335,00
11021914	1600-1650	345,00
11021915	1650-1700	355,00
11021916	1700-1750	370,00



### RJBC646

RESGUARDO DUCHE 2 FIXOS 2 PORTAS DE CORRER

Alt. 1950

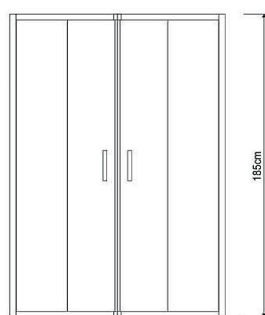

- Vidro 6mm transparente
- 2 Vidros Fixos 2 Portas de correr
- Reversível
- Perfil Cromo

CÓDIGO	MEDIDA	€
11021922	1600-1650	383,00
11021923	1650-1700	384,00
11021924	1700-1750	389,00
11021925	1750-1800	394,00
11021926	1800-1850	399,00
11021927	1850-1900	405,00
11021928	1900-1950	410,00
11021929	1950-2000	415,00
11021930	2000-2050	420,00
11021931	2050-2100	426,00
11021932	2100-2150	431,00
11021933	2150-2200	436,00
11021934	2200-2250	442,00

## RESGUARDOS DE DUCHE FRONTAIS



### WE-13

RESGUARDO DUCHE 1 FIXO 1 PORTA CORRER

Alt. 1950



- Vidro 6mm transparente
- 1 Vidro Fixo 1 Porta de correr
- Sem Perfil inferior
- Perfil Cromo

CÓDIGO	MEDIDA	€
11021551	1170-1210	325,00
11021552	1220-1260	330,00
11021553	1270-1310	345,00
11021554	1320-1360	340,00
11021555	1370-1410	395,00
11021557	1420-1460	350,00
11021556	1470-1510	355,00
11021558	1520-1560	360,00
11021559	1570-1610	365,00
11021560	1620-1660	370,00
11021561	1670-1710	375,00
11021562	1720-1760	380,00
11021563	1770-1810	385,00
11021564	1820-1860	395,00



### IZA-2 PLUS - perfil preto

RESGUARDO DUCHE 1 FIXO 1 PORTA DE CORRER

Alt. 1950

- Vidro 6mm transparente
- 1 Vidro Fixo 1 Porta de correr
- Sem Perfil inferior
- Perfil preto

CÓDIGO	MEDIDA	€
11022256	1190-1240	462,00
11022257	1240-1290	475,00
11022258	1290-1340	488,00
11022259	1340-1390	494,00
11022260	1390-1440	532,00
11022261	1440-1490	545,00
11022262	1490-1540	552,00
11022263	1540-1590	565,00
11022264	1590-1640	577,00
11022265	1640-1690	584,00
11022266	1690-1740	610,00
11022267	1740-1790	616,00
11022268	1790-1840	650,00
11022269	1840-1890	645,00
11022270	1890-1940	655,00
11022271	1940-2000	660,00

## RESGUARDOS DE DUCHE FRONTAIS



### WE-14

RESGUARDO DUCHE 2 FIXOS 2 PORTAS DE CORRER

Alt. 1950

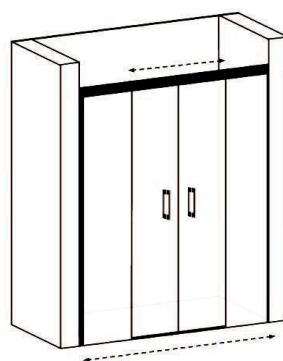

- Vidro 6mm transparente
- 2 Vidros Fixos 2 Portas de correr
- Sem Perfil inferior
- Perfil cromo

CÓDIGO	MEDIDA	€
11021571	1460-1510	410,00
11021572	1510-1560	415,00
11021573	1560-1610	420,00
11021574	1610-1660	425,00
11021575	1660-1710	430,00
11021576	1710-1760	435,00
11021577	1760-1810	440,00
11021578	1810-1860	445,00
11021579	1860-1910	450,00
11021580	1910-1960	455,00
11021581	1960-2010	460,00



### IZA-4 - perfil preto

RESGUARDO DUCHE 2 FIXOS 2 PORTAS DE CORRER

Alt. 1950

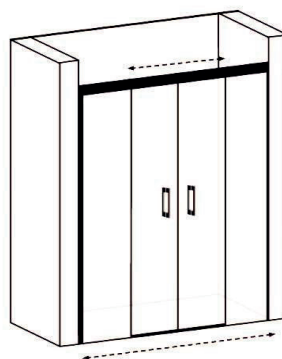

- Vidro 6mm transparente
- 2 Vidros Fixos 2 Portas de correr
- Sem Perfil inferior
- Perfil preto

CÓDIGO	MEDIDA	€
11022281	1470-1520	648,00
11022282	1520-1570	655,00
11022283	1570-1620	667,00
11022284	1620-1670	680,00
11022285	1670-1720	686,00
11022286	1720-1770	700,00
11022287	1770-1820	712,00
11022288	1820-1870	725,00
11022289	1870-1920	738,00
11022290	1920-1970	750,00
11022291	1970-2020	763,00

## RESGUARDOS DE DUCHE FRONTAIS



### RTJ618 anti calcário

FRONTAL FIXO

Alt. 2000

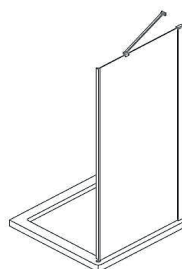

CÓDIGO	MEDIDA	€
11020175	900	255,00
11020176	1000	270,00
11020177	1100	281,00
11020178	1200	293,00
11020180	1300	320,00
11020179	1400	330,00
11020183	1500	315,00

- Vidro 8mm transparente
- Vidro fixo
- Braço incluído
- Perfil cromo



### CLS11 - perfil preto anti calcário

FRONTAL FIXO

Alt. 2000

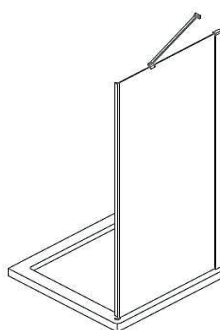

CÓDIGO	MEDIDA	€
11020911	800	296,00
11020912	900	299,00
11020913	1000	318,00
11020914	1100	322,00
11020915	1200	343,00
11020916	1300	377,00
11020917	1400	389,00

- Vidro 8mm transparente
- Vidro fixo
- Braço incluído
- Perfil preto

## RESGUARDOS DE DUCHE FRONTAIS



### WB8 BLACK

FRONTAL FIXO

Alt. 1950

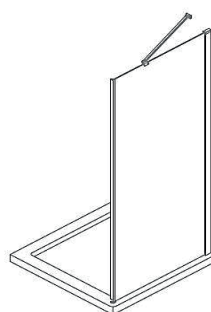

- Vidro 8mm transparente
- Vidro fixo Quadriculado preto
- Braço incluído
- Perfil preto

CÓDIGO	MEDIDA	€
11021131	900	339,00
11021132	1000	356,00
11021137	1100	381,00
11021133	1200	396,00
11021134	1300	415,00
11021135	1400	423,00
11021136	1500	450,00



### RJT618 SERIGRAFADO

FRONTAL FIXO

Alt. 1950

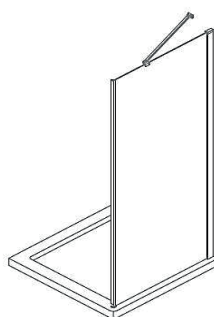

- Vidro 8mm transparente
- Vidro fixo Listado
- Braço incluído
- Perfil cromo

CÓDIGO	MEDIDA	€
11020922	900	300,00
11020923	1000	310,00
11020924	1100	320,00
11020925	1200	346,00
11020926	1300	370,00
11020927	1400	390,00

## RESGUARDOS DE DUCHE FRONTAIS



### AQHD PORTA ABRIR

Alt. 1950

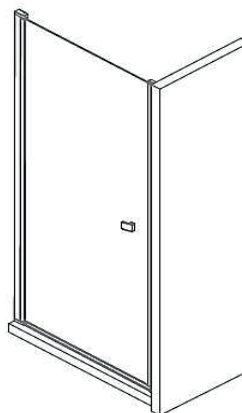

CÓDIGO	MEDIDA	€
11020119	660-700	<b>222,00</b>
11020118	710-750	<b>228,00</b>
11020120	760-800	<b>232,00</b>
11020123	810-850	<b>236,00</b>
11020121	860-900	<b>242,00</b>
11020117	910-950	<b>248,00</b>

- Vidro **6mm** transparente
- Porta Abrir P/Fora ou Dentro
- Perfil cromo



### H87B55

RESGUARDO DUCHE VIDRO FIXO+GIRATÓRIO 40CM

Alt. 1950



CÓDIGO	MEDIDA	€
11020950	900x400	<b>346,00</b>
11020951	1000x400	<b>353,00</b>

- Vidro **6mm** transparente
- 1 Vidro Fixo 90/100 Vidro giratório 40cm
- Perfil Cromo

# RESGUARDOS DE BANHEIRA



## PJM616

RESGUARDO BANHEIRA VIDRO GIRATÓRIO

Alt. 1400

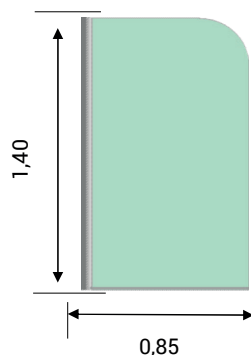

CÓDIGO	MED.	€
11020340	85x140	135,00



## PMJ616-1

RESGUARDO BANHEIRA VIDRO GIRATÓRIO

Alt. 1400

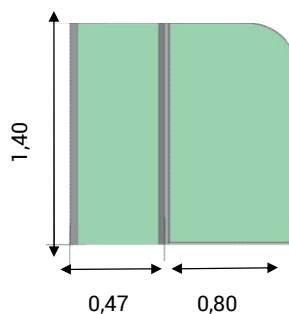

CÓDIGO	MED.	€
11020346	127x140	240,00



## RFA609-S

RESGUARDO BANHEIRA VIDRO GIRATÓRIO

Alt. 1400

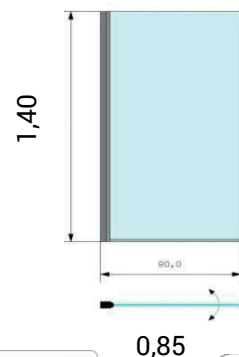

CÓDIGO	MED.	€
11020316	85x140	150,00



## L-500-C-2

Medidas: 800x800x2180

1.095€

## L-501-C-2

Medidas: 900x900x2180

1.210 €

## L-503-C-2

Medidas: 1000x1000x2180

1.280 €



### Especificações:

- Painéis traseiros em vidro.
- Painel de comando com rádio incluído.
- Ventoinha e colunas de som.
- Jatos de hidromassagem.
- Chuveiro de mão e de teto.
- Prateleira em vidro.
- Assento.

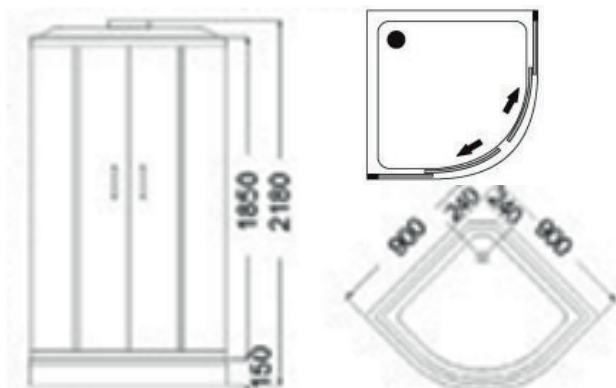

# L-501-C

Medidas: 900x900x2180 mm

1.235 €

# L-503-C

Medidas: 1000x1000x2180 mm

1.300 €



## Especificações:

- Painéis traseiros em vidro.
- Painel de comando com rádio incluído.
- Ventoinha e colunas de som.
- Jatos de hidromassagem.
- Chuveiro de mão e de teto.
- Prateleira em vidro.
- Assento.
- Massajador de pés.

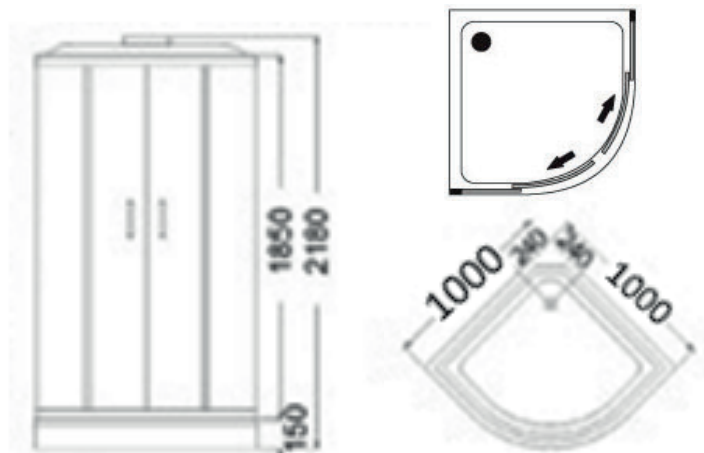

# L-500-CPS

Medidas: 800x800x2130 mm

950€

# L-501-CPS

Medidas: 900x900x2130 mm

1.010€



## Especificações:

- Painéis traseiros em vidro.
- Painel de comando com rádio incluído.
- Ventoinha e colunas de som.
- Jatos de hidromassagem.
- Chuveiro de mão e de teto.
- Prateleira em vidro.

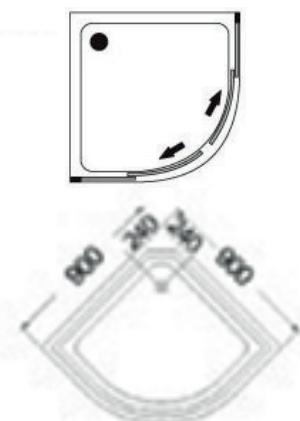

# L-519-C-2

Medidas: 900x900x2150

1.130 €

Medidas: 800x800x2150

1.060€



Especificações:

Painéis traseiros em vidro de 5 mm.

Painel de comando com rádio incluído

Jatos de hidromassagem.

Chuveiro de mão e de teto.

Luz interior.

Prateleira em vidro.

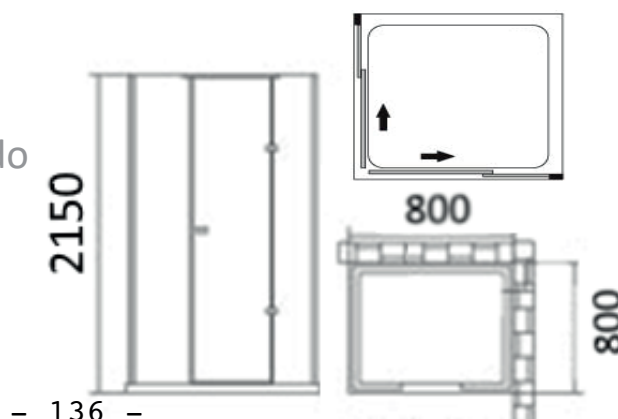

# AKL - 1355

Medidas: 800x1000x2100

995 €



## Especificações:

Painéis traseiros em vidro de 5 mm.

Chuveiro de mão.

Chuveiro de teto.

Prateleira em vidro.

Jatos de hidromassagem.

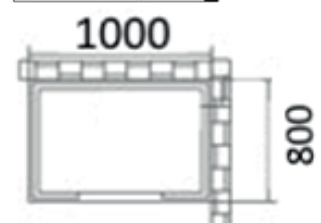
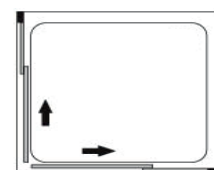

# AKL - 1357

Medidas: 700x1000x2100

1.050 €



## Especificações:

- Painéis traseiros em vidro de 5 mm.
- Painel de comando com rádio incluído.
- Jatos de hidromassagem.
- Chuveiro de mão e de teto.
- Luz interior.
- Prateleira em vidro.

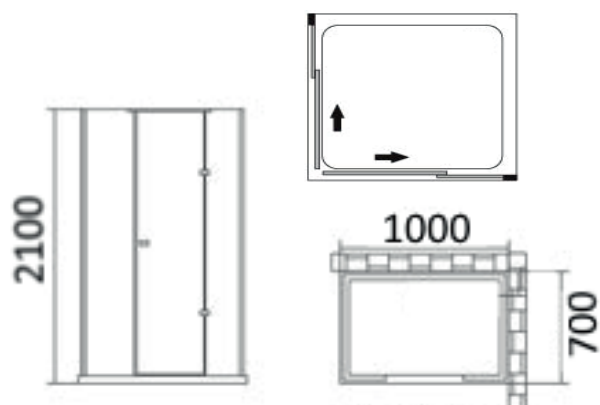

# L - 5521

Medidas: 800x1200x2150

1.365 €



## Especificações:

- Painéis traseiros em vidro de 5 mm.
- Painel de comando com rádio incluído.
- Jatos de hidromassagem.
- Chuveiro de mão e de teto.
- Luz interior.
- Prateleira em vidro.

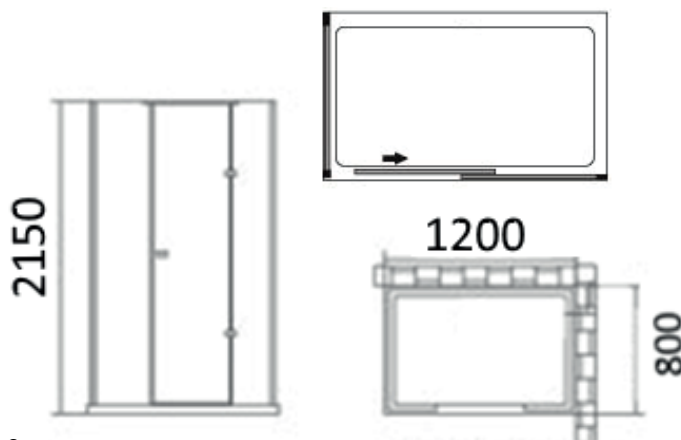

# L – 531-CX-2

Medidas: 850x1400x2150

1.580 €



Especificações:

Painéis traseiros em vidro de 5 mm.

Painel de comando com rádio incluído.

Jatos de hidromassagem.

Chuveiro de mão e de teto.

Luz interior.

Prateleira em vidro.

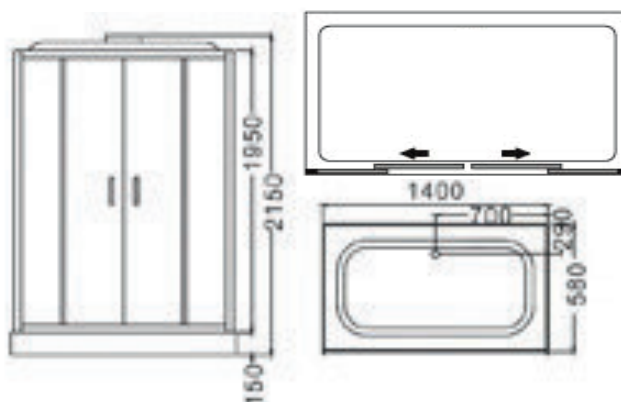

# L-631-C

Medidas: 1400x850x2180

1.750 €



Especificações:

Painéis traseiros em vidro.

Luz interior.

Painel de comando com rádio incluído.

Ventoinha e colunas de som.

Jatos de hidromassagem.

Chuveiro de mão e de teto.

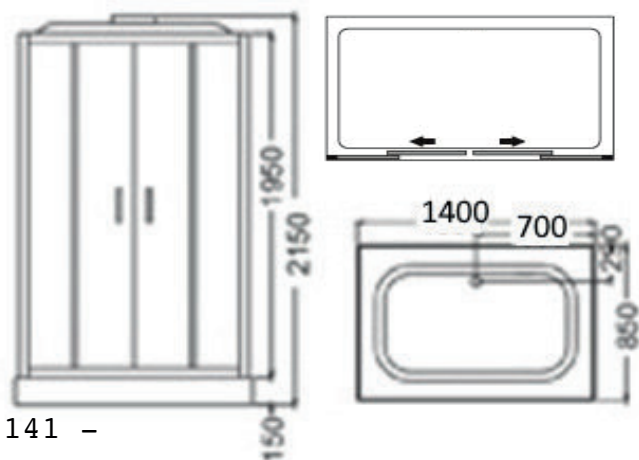

# COLUNAS DE HIDROMASSAGEM

## CM 8343 Inox

COLUNA HIDROMASSAGEM



CÓDIGO	MEDIDA	€
11046131	1500x200	298,00

- Corpo Inox
- Chuveiro de Topo
- Chuveiro Telefone
- Jactos Hidromassagem
- Monocomando

## CM 8343 Preto

COLUNA HIDROMASSAGEM



CÓDIGO	MEDIDA	€
11046134	1500x200	350,00

- Corpo Inox
- Chuveiro de Topo
- Chuveiro Telefone
- Jactos Hidromassagem
- Monocomando

## CM 8242 Inox

COLUNA HIDROMASSAGEM



CÓDIGO	MEDIDA	€
11046132	1500x200	332,00

- Corpo Inox
- Chuveiro de Topo
- Chuveiro Telefone
- Jactos Hidromassagem Orientáveis
- Monocomando Lateral

## CM 8242 Preto

COLUNA HIDROMASSAGEM



CÓDIGO	MEDIDA	€
11046133	1500x200	370,00

- Corpo Inox
- Chuveiro de Topo
- Chuveiro Telefone
- Jactos Hidromassagem Orientáveis
- Monocomando Lateral

# COLUNAS DE HIDROMASSAGEM

## SPR 88332

COLUNA HIDROMASSAGEM



CÓDIGO	MEDIDA	€
11046121	1500x220	350,00

- Corpo Inox
- Chuveiro de Topo
- Chuveiro Telefone
- Jactos Hidromassagem
- Monocomando

## SPR 88337

COLUNA HIDROMASSAGEM



CÓDIGO	MEDIDA	€
11046122	1500x200	340,00

- Corpo Inox
- Chuveiro de Topo
- Chuveiro Telefone
- Jactos Hidromassagem
- Monocomando

## SPR 88267

COLUNA HIDROMASSAGEM



CÓDIGO	MEDIDA	€
11046123	1600x220	350,00

- Corpo Inox
- Chuveiro de Topo
- Chuveiro Telefone
- Jactos Hidromassagem
- Monocomando

## SPR 88293

COLUNA HIDROMASSAGEM



CÓDIGO	MEDIDA	€
11046124	1600x220	350,00

- Corpo Inox
- Chuveiro de Topo
- Chuveiro Telefone
- Jactos Hidromassagem
- Monocomando

# CARRETOS P/ RESGUARDO

## 703-5

KIT CARRETOS P/ VIDRO DE 5/6mm



- Carretos Excêntricos
- Furo no Vidro de 12mm

CÓDIGO	U/BL	€
19010801	4	31,00

## RT013-014

KIT CARRETOS P/ VIDRO 5/6mm



- 2 Carretos superiores
- 2 Carretos Inferiores C/Mola

CÓDIGO	U/BL	€
19010811	4	49,00

## CRP11-11

KIT CARRETOS P/ VIDRO 5/6mm



- 2 Carretos superiores
- 2 Carretos Inferiores C/Mola

CÓDIGO	U/BL	€
19010802	4	21,50

## CRP11-21

KIT CARRETOS P/ VIDRO 5/6mm



- 2 Carretos Superiores
- 2 Carretos Inferiores C/ Mola

CÓDIGO	U/BL	€
19010803	4	22,50

## CRP11-22

KIT CARRETOS P/ VIDRO 5/6mm



- Carretos Duplos

CÓDIGO	U/BL	€
19010804	4	23,50

## CRP13-11

KIT CARRETOS P/ VIDRO 5/6mm



- 2 Carretos Superiores
- 2 Carretos Inferiores C/ Mola

CÓDIGO	U/BL	€
19010805	4	23,00

## CRP14-11

KIT CARRETOS P/ VIDRO 5/6mm



- 2 Carretos Superiores
- 2 Carretos Inferiores C/ Mola

CÓDIGO	U/BL	€
19010806	4	21,00

## CRP14-21

KIT CARRETOS P/ VIDRO 5/6mm



- 2 Carretos Superiores
- 2 Carretos Inferiores C/ Mola

CÓDIGO	U/BL	€
19010807	4	24,00

## CRP21-11

KIT CARRETOS P/ VIDRO 5/6mm



- Carretos Excéntricos

CÓDIGO	U/BL	€
19010808	4	16,00

# CARRETOS P/ RESGUARDO

## CRP22-22

KIT CARRETOS P/ VIDRO 5/6mm



- Carretos Duplos

CÓDIGO	U/BL	€
19010809	4	18,00

## CRP041

KIT CARRETOS P/ VIDRO 5/6mm



- Carretos C/Ranhura

CÓDIGO	U/BL	€
19010830	4	16,00

## CRP024

KIT CARRETOS P/ VIDRO 5/6mm



- Carretos

CÓDIGO	U/BL	€
19010828	4	16,00

## CRP10-10 2 furos

KIT CARRETOS P/ VIDRO 5/6mm



- 2 Carretos Duplos Superiores
- 2 Carretos Duplos Inferiores C/ Mola

CÓDIGO	U/BL	€
19010816	4	49,00

## CRP11-11 2 furos

KIT CARRETOS P/ VIDRO 5/6mm



- 2 Carretos Duplos Superiores
- 2 Carretos Inferiores C/ Mola

CÓDIGO	U/BL	€
19010832	4	21,50

## CRP059

KIT CARRETOS P/ VIDRO 5/6mm



- 2 Carretos Duplos Superiores
- 2 Carretos Inferiores

CÓDIGO	U/BL	€
19010817	4	24,00

## CRP076

KIT CARRETOS P/ VIDRO 5/6mm



- 2 Carretos Duplos Superiores
- 2 Carretos Inferiores C/ Mola

CÓDIGO	U/BL	€
19010818	4	22,50

## CRP105

KIT CARRETOS P/ VIDRO 5/6mm



- 2 Carretos Duplos Superiores
- 2 Carretos Inferiores C/ Mola

CÓDIGO	U/BL	€
19010819	4	22,50

## CRP015

KIT CARRETOS P/ VIDRO 5/6mm



- Carretos C/Ranhura e perno c/rotula

CÓDIGO	U/BL	€
19010820	4	18,00

# CARRETOS P/ RESGUARDO

## CRP018

KIT CARRETOS



• Carretos Simples perno c/encaixe roscado

CÓDIGO	U/BL	€
19010821	4	16,00

## CRP037

KIT CARRETOS P/ VIDRO 5/6mm



• Carretos Simples perno roscado

CÓDIGO	U/BL	€
19010831	4	16,00

## CRP042

KIT CARRETOS



• Carretos Simples perno roscado

CÓDIGO	U/BL	€
19010822	4	16,00

## CRP048

KIT CARRETOS



• Carretos Simples

CÓDIGO	U/BL	€
19010829	4	16,00

## CRP019

KIT CARRETOS P/ VIDRO 5/6mm



• Carretos Simples c/ranhura rosca interna

CÓDIGO	U/BL	€
19010823	4	16,00

## CRP022

KIT CARRETOS



• Carretos Simples c/ ranhura perno roscado

CÓDIGO	U/BL	€
19010824	4	18,00

## CRP049

KIT CARRETOS



• Carretos Simples

CÓDIGO	U/BL	€
19010825	4	16,00

## CRP060

KIT CARRETOS P/ VIDRO 5/6mm



• Carretos Simples

CÓDIGO	U/BL	€
19010826	4	24,00

## CRP052

KIT CARRETOS



• Carretos Simples

CÓDIGO	U/BL	€
19010827	4	16,00

# SUORTES P/ RESGUARDOS

## LMD

SUORTE AJUSTÁVEL P/RESG. DUCHE FIXO

CÓDIGO	MED.	€
19013734	800-1000	46,00



- Suporte p/ vidro de 8-10 mm
- Tubo em latão redondo cromado

## C7002

SUORTE AJUSTÁVEL P/RESG. DUCHE FIXO

CÓDIGO	MED.	€
19013733	800-1000	49,00



- Suporte p/ vidro de 8-10 mm
- Tubo em latão redondo cromado

## C7001

SUORTE RED. P/RESG. DUCHE FIXO

CÓDIGO	MED.	€
19013731	600-800	44,00



- Aplicação diagonal
- Suporte p/ vidro de 8-10 mm
- Tubo em latão cromado

## RETANGULAR

SUORTE RETANG. P/RESG. DUCHE FIXO

CÓDIGO	MED.	€
19013732	600-800	52,00



- Suporte p/ vidro de 8-10 mm
- Tubo em latão cromado

## 45°

PERFIL MAGNÉTICO P/PORTAS VIDRO

CÓDIGO	VIDRO	PAR €
35010581	5mm	30,00
35010582	6mm	30,00
35010583	8mm	32,00



## TIPO 4

PERFIL VEDAÇÃO P/PORTAS VIDRO

CÓDIGO	VIDRO	UNIT €
35010595	6mm	10,00
35010596	8mm	14,00



PERFIL LATERAL P/PORTAS E VIDROS FIXOS 2,00MT

CÓDIGO	VIDRO	UNIT €
35010592	5mm	10,00
35010589	6mm	10,00
35010590	8mm	14,00

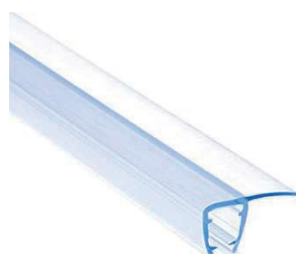

PERFIL INFERIOR P/PORTAS GIRATÓRIAS VIDRO 200CM

CÓDIGO	VIDRO	UNIT €
35010586	5mm	10,00
35010587	6mm	10,00
35010585	8mm	14,00





# SEPARADOR

## 4



- CHUVEIROS DE TETO
- HASTES DE CHUVEIRO
- MONOCOMANDOS CASA DE BANHO
- MONOCOMANDOS DE DUCHE C/ HASTE
- MONOCOMANDOS DE BALCÃO
- TORNEIRAS INFRAVERMELHO
- FLUXÓMETROS
- TORNEIRAS HOSPITALARES
- TORNEIRAS PEDAL
- TORNEIRAS INDUSTRIAIS



# CHUVEIROS DE TETO

## CHT894-S

CHUVEIRO INOX C/ LED'S

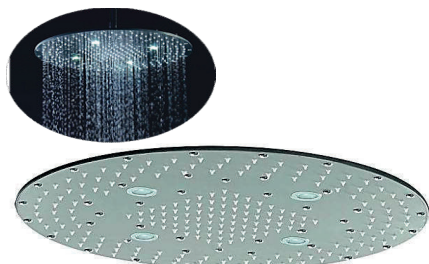

CÓDIGO	MEDIDA	€
08030345	Ø 400x9	285,00

## CHT853-S

CHUVEIRO INOX C/ LED'S

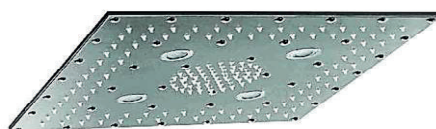

• Duas funções queda de água

CÓDIGO	MEDIDA	€
08030345	400x400x8	237,00

## YC85-03/ ATLAS R20

CHUVEIRO INOX EXTRA FINO

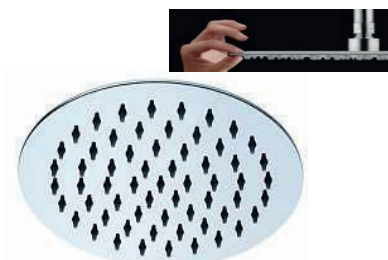

CÓDIGO	MEDIDA	€
08030222	Ø 200x2	31,40

## YC85-07/ ATLAS R30

CHUVEIRO INOX EXTRA FINO



CÓDIGO	MEDIDA	€
08030223	Ø 300x2	65,60

## YC85-09/ ATLAS R40

CHUVEIRO INOX EXTRA FINO

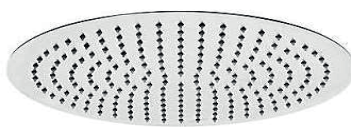

CÓDIGO	MEDIDA	€
08030225	Ø 400x2	111,10

## YC83-18

CHUVEIRO INOX EXTRA FINO



CÓDIGO	MEDIDA	€
08040128	300x200x2	110,00

## YC83-05/ ATLAS C25

CHUVEIRO INOX EXTRA FINO



CÓDIGO	MEDIDA	€
08040122	250x250x2	44,70

## YC83-07/ ATLAS C300

CHUVEIRO INOX EXTRA FINO

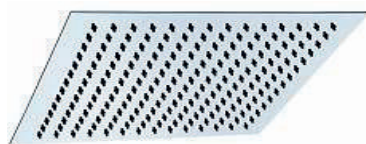

CÓDIGO	MEDIDA	€
08040123	300x300x2	65,40

## YC83-09/ ATLAS C40

CHUVEIRO INOX EXTRA FINO

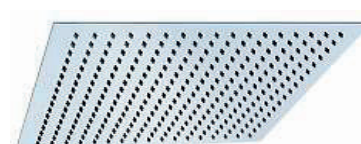

CÓDIGO	MEDIDA	€
08040125	400x400	110,70

# CHUVEIROS DE TETO

## YC83-12

CHUVEIRO INOX EXTRA FINO

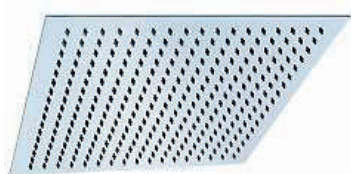

CÓDIGO	MEDIDA	€
08040127	600x600	340,00

## D12

CHUVEIRO CROMADO 200x200x10



CÓDIGO	ACABAM.	€
08010562	LATÃO	88,00
08010561	ABS	56,00

## D16

CHUVEIRO CROMADO Ø 200x10



CÓDIGO	ACABAM.	€
08010565	ABS	14,80

## 2104

CHUV. INOX C/ CASCATA + MONO. ENCASTRAR

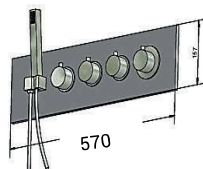
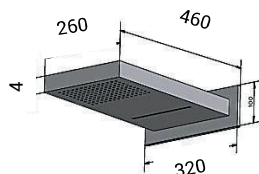

CÓDIGO	MEDIDA	€
08010411	320x460	503,00

## 2114

CHUV. INOX C/ CASCATA + MONO. ENCASTRAR

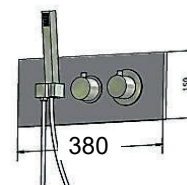
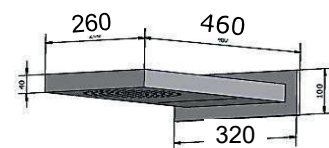

CÓDIGO	MEDIDA	€
08010415	320x460	503,00

## 1956 C CT

CHUVEIRO C/ HASTE



• Débito de água 6 Lt./m

CÓDIGO	MEDIDA	€
08020104	Ø 270x106	144,00

## 1957 C CT

CHUVEIRO C/ HASTE



• Débito de água 12 Lt./m

CÓDIGO	MEDIDA	€
08020105	Ø 270x140	152,00

## 1958 C CT

CHUVEIRO C/ HASTE



• Débito de água 12 Lt./m

• 2 Jatos de água diferente

CÓDIGO	MEDIDA	€
08020106	Ø 270x140	183,00

## CHUVEIROS DE TETO

### 1963 C CT

deca

CHUVEIRO C/ HASTE



- 5 Opções de jato

CÓDIGO	MEDIDA	€
08020111	Ø 270x75	99,00

### 1973 C CT

deca

CHUVEIRO C/ HASTE



CÓDIGO	MEDIDA	€
08020112	Ø 190x61	89,00

### AQG811

CHUVEIRO



CÓDIGO	MEDIDA	€
08010146	Ø 10	11,60

## HASTES CHUVEIRO

### CM A1002/ STILUS

HASTE CHUVEIRO



- latão cromado
- Rosca 1/2

CÓDIGO	MEDIDA	€
07020331	350mm	15,40

### CM A1005

HASTE CHUVEIRO



- latão cromado
- Rosca 1/2

CÓDIGO	MEDIDA	€
07020335	350mm	51,00

### CM A1001/ VARY

HASTE CHUVEIRO



- latão cromado
- Rosca 1/2

CÓDIGO	MEDIDA	€
07020321	350mm	18,00

### CM A1006/ CURVE

HASTE CHUVEIRO CURVA

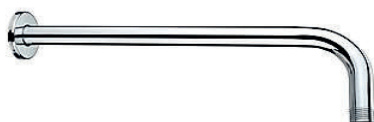

- latão cromado
- Rosca 1/2

CÓDIGO	MEDIDA	€
07020325	370mm	32,00

### CM A1003

HASTE CHUVEIRO TETO



CÓDIGO	MEDIDA	€
07020341	200mm	12,50
07020342	300mm	38,00

### CM A1004

HASTE CHUVEIRO TETO



CÓDIGO	MEDIDA	€
07020352	200mm	29,00
07020351	300mm	44,00

## RAMPAS DE DUCHE

### TH803

RAMPA SIMPLES



CÓDIGO	ACABAM.	€
07010104	CROMO	25,60

### D12100

RAMPA SIMPLES



CÓDIGO	ACABAM.	€
07020302	CROMO	88,50

### TH3022

RAMPA COMPLETA



CÓDIGO	ACABAM.	€
07010105	CROMO	45,00

## CHUVEIROS E SUPORTE

### 2007/ BLUET AQG

CHUVEIRO 3 POSIÇÕES - CX



CÓDIGO	ACABAM.	€
08010337	CROMO	6,64

### HS10/ 111 AQG

CHUVEIRO 3 POSIÇÕES



CÓDIGO	ACABAM.	€
08010301	CROMO	2,46

### ZION AQG

CHUVEIRO SIMPLES - BLS



CÓDIGO	ACABAM.	€
08010220	CROMO	4,55

### BARI

CHUVEIRO 3 POSIÇÕES - BLS



CÓDIGO	ACABAM.	€
08010156	CROMO	5,68

### CILINDRICO

CHUVEIRO TELEFONE



CÓDIGO	ACABAM.	€
08010307	ABS	8,10

### QUADRADO

CHUVEIRO TELEFONE



CÓDIGO	ACABAM.	€
08010310	ABS	8,50

# CHUVEIROS E SUPORTES

## ISABELA AQQ

CHUVEIRO 5 POSIÇÕES - CX



CÓDIGO	ACABAM.	€
08010337	CROMO	12,29

## ARTIC AQQ

CHUVEIRO TELEFONE 1 POSIÇÃO - BLS



CÓDIGO	ACABAM.	€
08010208	CROMO	8,88

## 8003

CHUVEIRO 3 POSIÇÕES



CÓDIGO	ACABAM.	€
08010202	CROMO	9,50

## 7805

CHUVEIRO 3 POSIÇÕES



CÓDIGO	ACABAM.	€
08010335	CROMO	18,00

## RETRATIL

CHUVEIRO P/ MONOCOMANDO



CÓDIGO	ACABAM.	€
08010302	CROMO	10,50

## 2510

CHUVEIRO P/ MONOCOMANDO RETRATIL



CÓDIGO	ACABAM.	€
08010304	CROMO	16,00

## KI BASIC C/SOTOP

CHUVEIRO HIGIÉNICO ABS LIGAÇÃO



CÓDIGO	ACABAM.	€
08010406	CROMO	61,00

## 765012

CHUV. HIGIÉNICO LATÃO C/ SUPORTE



CÓDIGO	ACABAM.	€
08010421	CROMO	90,00

## K66 DONE

CHUV. P/ MONOCOMANDO CABELEIREIRO



CÓDIGO	ACABAM.	€
08010321	PRETO	29,00

# S U P O R T E S

## K66DOCR

SUPORE P/ MONOC. CABELEIREIRO



CÓDIGO	MEDIDA	€
08010322	3/4	8,20

## CILINDRICO

SUPORE CHUVEIRO



CÓDIGO	ACABAM.	€
08010606	ABS	2,47

## QUADRADO

SUPORE CHUVEIRO



CÓDIGO	ACABAM.	€
08010602	ABS	3,77

## ABS

SUPORE CHUVEIRO



CÓDIGO	ACABAM.	€
08010625	ABS	1,74

## ABS ECO

SUPORE CHUVEIRO



CÓDIGO	ACABAM.	€
08010626	ABS	1,05

## RAY PRETO

SUPORE CHUVEIRO



CÓDIGO	ACABAM.	€
08010622	ABS	4,90

# TORNEIRAS CASA DE BANHO

Cartucho Ø 35mm

## SÉRIE CONE



CÓDIGO		€
01041201	BAIXO	67,50
01041601	ALTO	129,00

MONOCOMANDO LAVATÓRIO

CÓDIGO		€
01041301		67,57

MONOCOMANDO BIDE



- Ligação Flexível cromo
- Chuveiro telefone
- Suporte chuveiro

CÓDIGO		€
01041101		110,00

MONOCOMANDO BANHEIRA



- Ligação Flexível cromo
- Chuveiro telefone
- Suporte chuveiro

CÓDIGO		€
01011401		97,00

MONOCOMANDO CHUVEIRO

Cartucho Ø 35mm

## SÉRIE DALIS



CÓDIGO		€
01230201	BAIXO	49,00
01230601	ALTO	75,00

MONOCOMANDO LAVATÓRIO

CÓDIGO		€
01230301		49,00

MONOCOMANDO BIDE



- Ligação Flexível cromo
- Chuveiro telefone
- Suporte chuveiro

CÓDIGO		€
01230101		107,40

MONOCOMANDO BANHEIRA



- Ligação Flexível cromo
- Chuveiro telefone
- Suporte chuveiro

CÓDIGO		€
01230401		87,40

MONOCOMANDO CHUVEIRO

# TORNEIRAS CASA DE BANHO

## SÉRIE OMAR

Cartucho Ø 35mm



CÓDIGO		€
01020191	BAIXO	80,00
01020161	ALTO	114,00

MONOCOMANDO LAVATÓRIO

CÓDIGO		€
01020171		80,00

MONOCOMANDO BIDE



- Ligação Flexível cromo
- Chuveiro telefone
- Suporte chuveiro

CÓDIGO		€
01020151		124,00

MONOCOMANDO BANHEIRA



- Ligação Flexível cromo
- Chuveiro telefone
- Suporte chuveiro

CÓDIGO		€
01020181		107,00

MONOCOMANDO CHUVEIRO

Cartucho Ø 35mm

## SÉRIE AFONSO



CÓDIGO		€
01150603	BAIXO	49,00
01150601	ALTO	75,00

MONOCOMANDO LAVATÓRIO

CÓDIGO		€
01150301		49,00

MONOCOMANDO BIDE



- Ligação Flexível cromo
- Chuveiro telefone
- Suporte chuveiro

CÓDIGO		€
01150101		107,00

MONOCOMANDO BANHEIRA



- Ligação Flexível cromo
- Chuveiro telefone
- Suporte chuveiro

CÓDIGO		€
01150401		87,40

MONOCOMANDO CHUVEIRO

# TORNEIRAS CASA DE BANHO

Cartucho Ø 35mm

## SÉRIE ELEGANCE



CÓDIGO		€
01690201	BAIXO	63,30
01690601	ALTO	78,60

MONOCOMANDO LAVATÓRIO



CÓDIGO		€
01690301		63,30

MONOCOMANDO BIDE



- Ligação Flexível cromo
- Chuveiro telefone
- Suporte chuveiro

CÓDIGO		€
01690101		113,00

MONOCOMANDO BANHEIRA



- Ligação Flexível cromo
- Chuveiro telefone
- Suporte chuveiro

CÓDIGO		€
01690401		98,60

MONOCOMANDO CHUVEIRO

Cartucho Ø 35mm

## SÉRIE GLÓRIA



CÓDIGO		€
01020201		66,70

MONOCOMANDO LAVATÓRIO



CÓDIGO		€
01020301		66,70

MONOCOMANDO BIDE



- Ligação Flexível cromo
- Chuveiro telefone
- Suporte chuveiro

CÓDIGO		€
01020101		109,00

MONOCOMANDO BANHEIRA



- Ligação Flexível cromo
- Chuveiro telefone
- Suporte chuveiro

CÓDIGO		€
01020401		87,60

MONOCOMANDO CHUVEIRO

# TORNEIRAS CASA DE BANHO

Cartucho Ø 35mm

## SÉRIE IMPERIAL



**CÓDIGO** €  
01020502 **66,70**  
MONOCOMANDO LAVATÓRIO



**CÓDIGO** €  
01020503 **66,70**  
MONOCOMANDO BIDE



- Ligação Flexível cromo
- Chuveiro telefone
- Suporte chuveiro

**CÓDIGO** €  
01020501 **109,00**  
MONOCOMANDO BANHEIRA



- Ligação Flexível cromo
- Chuveiro telefone
- Suporte chuveiro

**CÓDIGO** €  
01020504 **87,60**  
MONOCOMANDO CHUVEIRO

Cartucho Ø 35mm

## SÉRIE SIENA



**CÓDIGO** €  
01580201 **57,20**  
MONOCOMANDO LAVATÓRIO



**CÓDIGO** €  
01580301 **57,20**  
MONOCOMANDO BIDE



- Ligação Flexível cromo
- Chuveiro telefone
- Suporte chuveiro

**CÓDIGO** €  
01580101 **94,30**  
MONOCOMANDO BANHEIRA



- Ligação Flexível cromo
- Chuveiro telefone
- Suporte chuveiro

**CÓDIGO** €  
01580401 **82,00**  
MONOCOMANDO CHUVEIRO

# TORNEIRAS CASA DE BANHO

Cartucho Ø 35mm

## SÉRIE ELLA



CÓDIGO		€
01330201	BAIXO	82,00
01330601	ALTO	124,00

CÓDIGO	€
01330301	88,00

MONOCOMANDO LAVATÓRIO

MONOCOMANDO BIDE



- Ligação Flexível cromo
- Chuveiro telefone
- Suporte chuveiro



- Ligação Flexível cromo
- Chuveiro telefone
- Suporte chuveiro

CÓDIGO	€
01330101	133,00

CÓDIGO	€
01330401	116,00

MONOCOMANDO BANHEIRA

MONOCOMANDO CHUVEIRO

Cartucho Ø 35mm

## SÉRIE QUADRO



CÓDIGO	€
01340201	77,90

CÓDIGO	€
01340301	77,90

MONOCOMANDO LAVATÓRIO

MONOCOMANDO BIDE

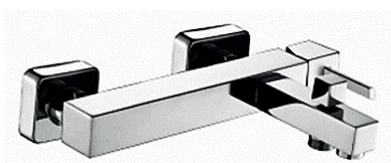

- Ligação Flexível cromo
- Chuveiro telefone
- Suporte chuveiro



- Ligação Flexível cromo
- Chuveiro telefone
- Suporte chuveiro

CÓDIGO	€
01340101	132,00

CÓDIGO	€
01340401	112,00

MONOCOMANDO BANHEIRA

MONOCOMANDO CHUVEIRO

# TORNEIRAS CASA DE BANHO

Cartucho Ø 40mm

## SÉRIE FINE



**CÓDIGO** €  
01691201 **37,80**  
MONOCOMANDO LAVATÓRIO

**CÓDIGO** €  
01691301 **37,80**  
MONOCOMANDO BIDE

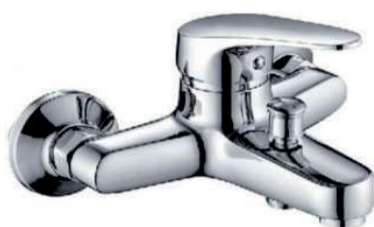

- Ligação Flexível cromo
- Chuveiro telefone
- Suporte chuveiro

**CÓDIGO** €  
01691101 **59,00**  
MONOCOMANDO BANHEIRA



- Ligação Flexível cromo
- Chuveiro telefone
- Suporte chuveiro

**CÓDIGO** €  
01691401 **52,00**  
MONOCOMANDO CHUVEIRO

Cartucho Ø 40mm

## SÉRIE ECO



**CÓDIGO** €  
01170201 **25,30**  
MONOCOMANDO LAVATÓRIO

**CÓDIGO** €  
01170301 **25,30**  
MONOCOMANDO BIDE



- Ligação Flexível cromo
- Chuveiro telefone
- Suporte chuveiro

**CÓDIGO** €  
01170101 **46,40**  
MONOCOMANDO BANHEIRA



- Ligação Flexível cromo
- Chuveiro telefone
- Suporte chuveiro

**CÓDIGO** €  
01170401 **41,20**  
MONOCOMANDO CHUVEIRO

## MONOCOMANDOS DUCHE C/ HASTE

### GT372

MONOCOMANDO COM HASTE



- Monocomando de Duche
- Chuveiro Quadrado 20cm
- Chuveiro Telefone
- Haste de Chuv. Ajustável
- Suporte de Chuveiro
- Ligação Flexível Cromada
- Inversor Lateral

CÓDIGO	€
01300111	267,00

### ELIOT

MONOCOMANDO COM HASTE



- Monocomando de Duche
- Chuveiro Quadrado 20cm
- Chuveiro Telefone
- Haste de Chuv. Ajustável
- Suporte de Chuveiro
- Ligação Flexível Cromada

CÓDIGO	€
01300115	328,00

### GT812

MONOCOMANDO COM HASTE



- Monocomando de Duche
- Chuveiro Redondo 20cm
- Chuveiro Telefone
- Haste de Chuv. Ajustável
- Suporte de Chuveiro
- Ligação Flexível Cromada

CÓDIGO	€
01300103	125,00

### AFONSO

MONOCOMANDO COM HASTE



- Monocomando de Duche
- Chuveiro Redondo 20cm
- Chuveiro Telefone
- Haste de Chuv. Ajustável
- Suporte de Chuveiro
- Ligação Flexível Cromada
- Inversor Lateral

CÓDIGO	€
01300211	160,00

## MONOCOMANDOS DUCHE C/ HASTE DIGITAL

### DIGI251

MISTURADORA COM HASTE DIGITAL



- Misturadora duche
- Comandos selectores individuais
- Chuveiro Telefone 2 posições
- Chuveiro de duche
- Chuveiro higiénico
- Ligação Chuveiro

CÓDIGO	€
01300251	255,00

### DIGI252

MISTURADORA COM HASTE DIGITAL



- Misturadora duche
- Comandos selectores individuais
- Chuveiro Telefone 2 posições
- Chuveiro de duche
- Chuveiro higiénico
- Ligação Chuveiro

CÓDIGO	€
01300252	235,00

### DIGI261

MISTURADORA COM HASTE DIGITAL



- Misturadora duche
- Comandos selectores individuais
- Informação temperatura digital
- Chuveiro Telefone 2 posições
- Chuveiro de duche
- Chuveiro higiénico
- Ligação Chuveiro

CÓDIGO	€
01300261	280,00

### DIGI262

MISTURADORA COM HASTE DIGITAL



- Misturadora duche
- Comandos selectores individuais
- Informação temperatura digital
- Chuveiro Telefone 2 posições
- Chuveiro de duche
- Chuveiro higiénico
- Ligação Chuveiro

CÓDIGO	€
01300262	278,00

## MONOCOMANDOS DUCHE ENCASTRAR

### AFONSO

KIT COMPLETO

CROMADO



CÓDIGO	ACABAM.	€
01302071	CROMO	184,00

### AFONSO

KIT COMPLETO

PRETO



CÓDIGO	ACABAM.	€
01302072	PRETO	199,00

### AFONSO

KIT COMPLETO

DOURADO ESCOVADO



CÓDIGO	ACABAM.	€
01302035	OURO	260,00

### AFONSO

KIT COMPLETO

INOX MATE



CÓDIGO	ACABAM.	€
01302074	INOX MATE	200,00

## MONOCOMANDOS DUCHE ENCASTRAR

### TH302

COM CAIXA/ 2 VIAS



CÓDIGO	ACABAM.	€
01302113	CROMO	140,00

### TH303

COM CAIXA/ 3 VIAS



CÓDIGO	ACABAM.	€
01302135	CROMO	155,00

### TH202

COM CAIXA/ 2 VIAS

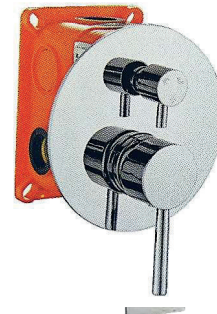

CÓDIGO	ACABAM.	€
01302124	CROMO	133,00

### TH203

COM CAIXA/ 3 VIAS

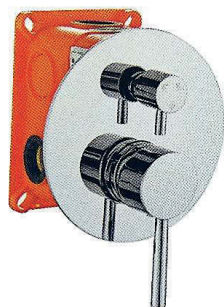

CÓDIGO	ACABAM.	€
01302125	CROMO	147,00

### QM1434

1 VIA



CÓDIGO	ACABAM.	€
01302110	CROMO	63,00

### CASCATA

MONOC. BANHEIRA



CÓDIGO	ACABAM.	€
01510102	CROMO	715,00

### SILING

MONOC. BANHEIRA



CÓDIGO	ACABAM.	€
01510103	CROMO	445,00

### 3067

BICA PAREDE P/ BANHEIRA



CÓDIGO	ACABAM.	€
01302130	CROMO	22,00

### PLANA

BICA PAREDE P/ BANHEIRA



CÓDIGO	ACABAM.	€
01302128	CROMO	26,00

## MONOCOMANDOS DUCHE ENCASTRAR

### TH221

TOMADA ÁGUA C/ SUPORTE



CÓDIGO	ACABAM.	€
01303103	CROMO	29,90

### TH331

TOMADA ÁGUA C/ SUPORTE



CÓDIGO	ACABAM.	€
01303109	CROMO	33,00

### TH221C preto

TOMADA ÁGUA C/ SUPORTE



CÓDIGO	ACABAM.	€
01303117	CROMO	32,00

## MONOCOMANDOS LAVATÓRIO ENCASTRAR

### LINEA 600

MONOC. LAVATÓRIO ENCASTRAR



CÓDIGO	ACAB.	€
01302318	CROMO	75,00

### LINEA 600 preto

MONOC. LAVATÓRIO ENCASTRAR



CÓDIGO	ACAB.	€
01302319	PRETO	85,00

### LINEA 600 dourado

MONOC. LAVATÓRIO ENCASTRAR



CÓDIGO	ACAB.	€
01302320	DOURADO	98,00

### LINEA 601

MONOC. LAVATÓRIO ENCASTRAR



CÓDIGO	ACAB.	€
01302307	CROMO	130,00

### PLAN 702

MONOC. LAVATÓRIO ENCASTRAR



CÓDIGO	ACAB.	€
01302311	CROMO	136,00

### DUNA CLASSICA

MONOC. ENCASTRAR PAREDE P/ LAVAT.



CÓDIGO	ACAB.	€
01302306	CROMO	248,00

## MONOCOMANDOS BALCÃO C/ CHUVEIRO

### TH791 bica giratoria 21cm

MONOCOMANDO BALCÃO



CÓDIGO	ACABAMENTO	€
01252203	CROMO	79,00

### TH709

MONOCOMANDO C/ CHUVEIRO RETRÁTIL



CÓDIGO	ACABAMENTO	€
01252206	CROMO	103,00

### N5/ AQG

MONOCOMANDO C/ CHUVEIRO RETRÁTIL



CÓDIGO	ACABAMENTO	€
01250801	CROMO	60,50

### N15

MONOCOMANDO C/ CHUVEIRO RETRÁTIL



CÓDIGO	ACABAMENTO	€
01212115	CROMO	223,00

### N10

MONOCOMANDO C/ CHUVEIRO RETRÁTIL



CÓDIGO	ACABAMENTO	€
01252105	CROMO	132,00

### N3

MONOCOMANDO C/ CHUVEIRO RETRÁTIL



CÓDIGO	ACABAMENTO	€
01250701	CROMO	82,00

## MONOCOMANDOS BALCÃO CROMADO

### L9

MONOC. BICA GIRATÓRIA QUADRADA



CÓDIGO	ACABAMENTO	€
01252201	CROMO	93,70

### L24

MONOC. BICA GIRATÓRIA QUADRADA



CÓDIGO	ACABAMENTO	€
01252224	CROMO	103,00

### L25

MONOCOMANDO BICA GIRATÓRIA



CÓDIGO	ACABAMENTO	€
01252225	CROMO	54,40

## MONOCOMANDOS BALCÃO CROMADO

### L8 TUBO

MONOCOMANDO BICA GIRATÓRIA



CÓDIGO	ACABAMENTO	€
01280502	CROMO	48,60

### L8 PF

MONOC. BICA FUNDIDA PARAFUSO



CÓDIGO	ACABAMENTO	€
01280503	CROMO	75,00

### L8 FF

MONOC. BICA FUNDIDA C/ FEMEA



CÓDIGO	ACABAMENTO	€
01280501	CROMO	67,20

### I-2

MONOC. MANIPULO LATERAL



CÓDIGO	ACABAMENTO	€
01140501	CROMO	29,80

### L17

MONOC. BICA GIRATÓRIA



CÓDIGO	ACABAMENTO	€
01252217	CROMO	72,00

### I6

MONOCOMANDO BICA GIRATÓRIA



CÓDIGO	ACABAMENTO	€
01140801	CROMO	58,00

### I-1

MONOCOMANDO BICA GIRATÓRIA



CÓDIGO	ACABAMENTO	€
01140601	CROMO	34,00

### BICA FLEXIVÉL

MONOCOMANDO BICA FLEXIVÉL PRETO



CÓDIGO	ACABAMENTO	€
01252409	CROMO	66,00

### WOLOBBY INOX

MONOCOMANDO BICA FLEXIVÉL PRETO



CÓDIGO	ACABAMENTO	€
01252408	INOX	80,40

## MONOCOMANDOS BALCÃO INOX

**TH3006**

MONOC. BICA GIRATÓRIA



CÓDIGO	ACABAMENTO	€
01252310	INOX	42,20

**TH3007**

MONOC. BICA GIRATÓRIA



CÓDIGO	ACABAMENTO	€
01252311	INOX	42,20

**TH1001**

TORN. BICA GIRATÓRIA 1 ÁGUA



CÓDIGO	ACABAMENTO	€
03030210	CROMO	22,00

## MONOCOMANDOS BANCA PAREDE

**I-3**

MONOCOMANDO BANCA PAREDE



CÓDIGO	ACABAMENTO	€
01141101	CROMO	57,00

**I-10**

MONOCOMANDO BANCA PAREDE



CÓDIGO	ACABAMENTO	€
01141202	CROMO	57,00

# TORNEIRAS INFRAVERMELHO

## GELAQQ007/ SAMOA ONE

TORNEIRA LAVAT. 1 ÁGUA



CODIGO	SISTEMA	€
04010120	ELECT./BAT	146,30

## GELAQQ009/ SAMOA MIX

MISTURADORA LAVATÓRIO



MISTURADOR  
POR BAIXO DO  
LAVATÓRIO

CODIGO	SISTEMA	€
04010121	ELECT./BAT	170,30

## GELAQQ005/ FIJI ONE

TORNEIRA LAVATÓRIO



CODIGO	SISTEMA	€
04010125	ELECT./BAT	149,10

## GELAQQ001/ FIJI ADVANCE

MISTURADORA LAVATÓRIO



CODIGO	SISTEMA	€
04010126	ELECT./BAT	185,30

## GS-8802 LR

MISTURADORA LAVATÓRIO



CODIGO	SISTEMA	€
04010161	BATERIA/DC.	190,00

## GS-8806 LR

MISTURADORA LAVATÓRIO



CODIGO	SISTEMA	€
04010163	BATERIA/DC.	210,00

## GS-8826

TORNEIRA LAVATÓRIO



CODIGO	SISTEMA	€
04010133	ELECT./BAT	180,00
04010134	BATERIA/DC.	170,00

## GS-8827

TORNEIRA LAVATÓRIO



CODIGO	SISTEMA	€
04010135	ELECT./BAT	180,00
04010136	BATERIA/DC.	170,00

## TH-532

TORNEIRA LAVATÓRIO ALTA



CODIGO	SISTEMA	€
04010140	ELECT./BAT	157,20

# TORNEIRAS INFRAVERMELHO

## TH-531

TORNEIRA LAVATÓRIO ENCASTRAR



CODIGO	SISTEMA	€
04010145	ELECT./BAT	157,20

## TH-529 ALTA

FLUXÓMETRO URINOL



CODIGO	SISTEMA	€
04010202	ELECT./BAT	165,00

## TH-529

FLUXÓMETRO URINOL



CODIGO	SISTEMA	€
04010203	ELECT./BAT	140,00

## GS-5804

FLUXÓMETRO SANITA



CODIGO	SISTEMA	€
04010204	ELECT./BAT	190,00
04010304	BATERIA/DC.	180,00

## GS-6801

FLUXÓMETRO URINOL



CODIGO	SISTEMA	€
04010205	ELECT./BAT	150,00
04010305	BATERIA/DC.	140,00

## \*ASP4-K/\*\*ASP4-KB

FLUX. URINOL INFRAVERMELHOS



CODIGO	SISTEMA	€
*04010214	ELECT	268,00
**04010213	D/C	363,00

## \*ASP4/ \*\*ASP4-B

FLUX. URINOL INFRAVERMELHOS



CODIGO	SISTEMA	€
*04010216	ELECT.	284,00
**04010215	A/C	366,00

## ASP4-KT

FLUX. URINOL INFRAVERMELHOS



CODIGO	SISTEMA	€
04010218	ELECT.	477,00
04010219	MANUAL	477,00

# FLUXÓMETROS

## GN1187 06

FLUXÓMETRO SANITA



CÓDIGO	MEDIDA	€
04030207	3/4	108,00
04030208	1"	115,00

## GB1040 04

FLUXÓMETRO SANITA



CÓDIGO	MEDIDA	€
04030209	3/4	106,00
04030210	1"	113,00

## R731

FLUXÓMETRO SANITA



CÓDIGO	MEDIDA	€
04030101	3/4	134,00

## R734

FLUXÓMETRO SANITA



CÓDIGO	MEDIDA	€
04030102	3/4	170,00

## TE171

FLUXÓMETRO SANITA ENCASTRAR



CÓDIGO	MEDIDA	€
04030202	3/4	110,00
04030203	1"	115,00

## TE170

FLUXÓMETRO SANITA



CÓDIGO	MEDIDA	€
04030200	3/4	105,00
04030201	1"	110,00

## GB1161 04

TORN. TEMPORIZADA URINOL ENCASTRAR



CÓDIGO	MEDIDA	€
04030216	1/2	75,00

## GB1175

TORN. TEMPORIZADA URINOL EXT.



CÓDIGO	MEDIDA	€
04030217	1/2	78,00

## GB1175 04

TOR. TEMPORIZADA ENCASTRAR DUCHE



CÓDIGO	MEDIDA	€
04030221	1/2	75,00

## GB1172 04

TORN. TEMPORIZADA DUCHE EXT.



CÓDIGO	MEDIDA	€
04041101	1/2	78,00

# TEMPORIZADAS

## CM1102

TORN. DE LAVATÓRIO TEMPORIZADA



CÓDIGO	MEDIDA	€
03060202	1	55,00

## CM1103

MIST. DE LAVATÓRIO TEMPORIZADA



CÓDIGO	MEDIDA	€
03060203	1/2	76,00

## CM518

TORN. DE LAVATÓRIO TEMPORIZADA



CÓDIGO	MEDIDA	€
03060210	1/2	58,00

## TH503

TORN. DE LAVATÓRIO TEMPORIZADA



CÓDIGO	MEDIDA	€
03060211	1/2	47,00

## CM1112

TORN. DE LAVATÓRIO TEMPORIZADA



CÓDIGO	MEDIDA	€
03060205	1/2	58,00

## CM1113

TORN. DE LAVATÓRIO TEMPORIZADA



CÓDIGO	MEDIDA	€
03060206	1/2	58,00

## TORN. DE LAVATÓRIO

TEMPORIZADA



CÓDIGO	MEDIDA	€
03060201	1/2	43,00

## GB1166

TORN. TEMPORIZADA PAREDE



CÓDIGO	MEDIDA	€
03060209	1/2	45,00

## TORN. DE URINOL

TEMPORIZADA



CÓDIGO	MEDIDA	€
03060101	1/2	36,80

## TH505

TORN. TEMPORIZADA URINOL EXTERIOR



CÓDIGO	MEDIDA	€
03060103	1/2	37,00

## TH507

TORN. TEMPORIZADA CHUVEIRO



CÓDIGO	MEDIDA	€
03060103	1/2	35,00

## TH019

MIST. TEMPORIZADA CHUVEIRO



CÓDIGO	MEDIDA	€
03060107	1/2	137,00

## TORNEIRAS HOSPITALARES E CABELEIREIRO

### MONOC. LAVATÓRIO



CÓDIGO	ACABAM.	€
04010602	CROMO	47,00

### TORN. HOSPITALAR

1 ÁGUA



CÓDIGO	ACABAM.	€
04010601	CROMO	28,00

### TH531

MONOC. HOSPITALAR



CÓDIGO	ACABAM.	€
04010611	CROMO	57,00

### 1210

TORNEIRA HOSPITALAR



CÓDIGO	ACABAM.	€
04010312	CROMO	66,00

### TORN. PAREDE

TORNEIRA HOSPITALAR



CÓDIGO	ACABAM.	€
04010610	CROMO	25,00

### MONOC. DUCHE



CÓDIGO	ACABAM.	€
04010608	CROMO	66,00

### MONOC. BALCÃO

HOSPITALAR



CÓDIGO	ACABAM.	€
04010605	CROMO	49,00

### TH621

HOSPITALAR



CÓDIGO	ACABAM.	€
04010612	CROMO	83,00

### K66

MONOC. CABELEIREIRO



CÓDIGO	ACABAM.	€
04010621	CROMO	98,30
04010623	CLASSICO	72,00

# TORNEIRAS PEDAL

## R560 283

TORN. PEDAL FIXAR AO CHÃO



CÓDIGO	MEDIDA	€
04020201	1/2	143,50

## R562 283

TORN. PEDAL FIXAR AO CHÃO



CÓDIGO	MEDIDA	€
04020211	1/2	169,00

## R550 283

MIST. 2 PEDAIS FIXAR AO CHÃO



CÓDIGO	MEDIDA	€
04020102	1/2	223,30

## R552 283

MIST. 2 PEDAIS FIXAR A PAREDE



CÓDIGO	MEDIDA	€
04020111	1/2	278,00

## R566 283

MIST. PEDAL FIXAR AO CHÃO REGRESSIVA



CÓDIGO	MEDIDA	€
04020221	1/2	217,30

## 9057A

MIST. PEDAL FIXAR AO CHÃO



CÓDIGO	MEDIDA	€
04020150	1/2	74,00

## TH585

TORN. PEDAL FIXAR AO CHÃO



CÓDIGO	MEDIDA	€
04020152	1/2	69,00

## TH586

MIST. PEDAL FIXAR AO CHÃO PROGRESSIVA



CÓDIGO	MEDIDA	€
04020151	1/2	80,00

## 07IND1P1CR AQQ

TORN. PEDAL FIXAR AO CHÃO



CÓDIGO	MEDIDA	€
04020251	1/2	87,20

## 07IND1PMCR AQQ

MIST. PEDAL FIXAR AO CHÃO PROGRESSIVA



CÓDIGO	MEDIDA	€
04020252	1/2	134,60

## BICA P/ TORNEIRA

BICA P/ TORN. E MISTURADORA DE PEDAL



CÓDIGO	MEDIDA	€
04020351	1/2	16,00

## R590 283

BICA P/ TORN. E MISTURADORA DE PEDAL



CÓDIGO	MEDIDA	€
04020350	1/2	38,40

## COZINHA INDUSTRIAL

### TH010

MIST. PAREDE INDUSTRIAL COM CHUVEIRO



CÓDIGO	ACABAM.	€
04020417	CROMO	315,00

### TH015

MIST. INDUSTRIAL COM CHUVEIRO



CÓDIGO	ACABAM.	€
04020416	CROMO	198,00

### TH017

MONOC. PAREDE C/ CHUVEIRO



CÓDIGO	ACABAM.	€
04020403	CROMO	320,00

### TH080

MIST. PAREDE C/ CHUVEIRO E BICA



CÓDIGO	ACABAM.	€
04020404	CROMO	430,00

### TH016

MONOC. COZINHA C/ CHUVEIRO



CÓDIGO	ACABAM.	€
04020418	CROMO	300,00

### TH081

MIST. COM CHUVEIRO E BICA



CÓDIGO	ACABAM.	€
04020415	CROMO	430,00

## TORNEIRAS SIMPLES

### TORNEIRA ESQUADRIA

CILINDRICA 1/4 DE VOLTA



CÓDIGO	MEDIDA	€
03010106	1/2x3/8	8,60
03010101	1/2x1/2	8,60

### TORNEIRA ESQUADRIA

QUADRADA 1/4 DE VOLTA



CÓDIGO	MEDIDA	€
03010107	1/2x3/8	8,60
03010102	1/2x1/2	8,60

### TORNEIRA ESQUADRIA

DE CORTE



CÓDIGO	MEDIDA	€
16040621	1/2x3/8	3,60
16040622	1/2x1/2	3,60
16040623	1/2x3/4	4,90

### TORNEIRA ESQUADRIA

DE CORTE C/ FILTRO



CÓDIGO	MEDIDA	€
16040601	1/2x3/8	4,60
16040602	1/2x1/2	4,70

### TORNEIRA ESQUADRIA

DE CORTE C/ FILTRO LONGA

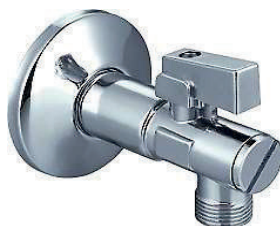

CÓDIGO	MEDIDA	€
16040611	1/2x3/8	5,00
16040610	1/2x1/2	5,20

### TORNEIRA MAQ. DE LAVAR



CÓDIGO	MEDIDA	€
16040632	1/2x3/4	5,80

### TORNEIRA DE BALCÃO

TIPO MONOCOMANDO 1 ÁGUA



CÓDIGO	MEDIDA	€
03030101	1/2	49,00

### TORNEIRA DE LAVATÓRIO

TIPO MONOCOMANDO 1 ÁGUA



CÓDIGO	MEDIDA	€
03040101	1/2	30,00





# SEPARADOR

## 5

- TOALHEIROS
- PORTA PIAÇABA
- SABONETEIRAS



# TOALHEIROS

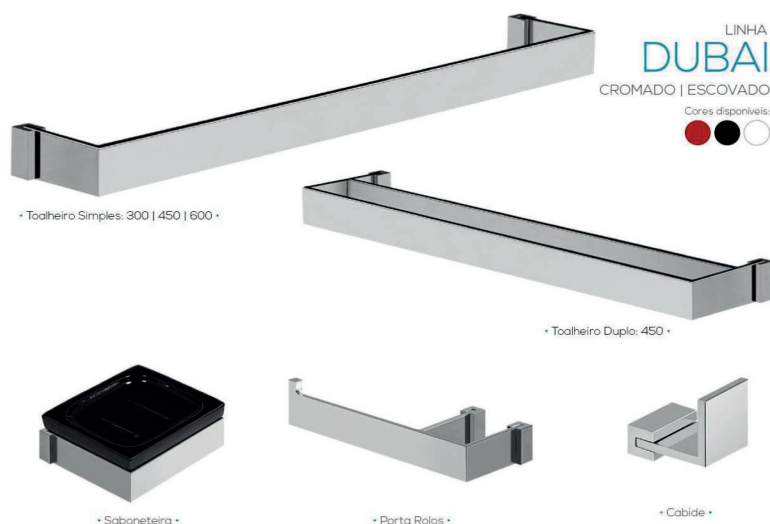

LATÃO CROMO		
CÓDIGO	DESCRIÇÃO	€
05032101	Barra 30cm	<b>39,20</b>
05032102	Barra 40cm	<b>43,00</b>
05032104	Barra 60cm	<b>46,00</b>
05032105	Barra Duplo 40cm	<b>43,00</b>
05032106	Saboneteira	<b>57,00</b>
05032109	Porta Rolo	<b>43,00</b>
05032110	Cabide	<b>22,00</b>

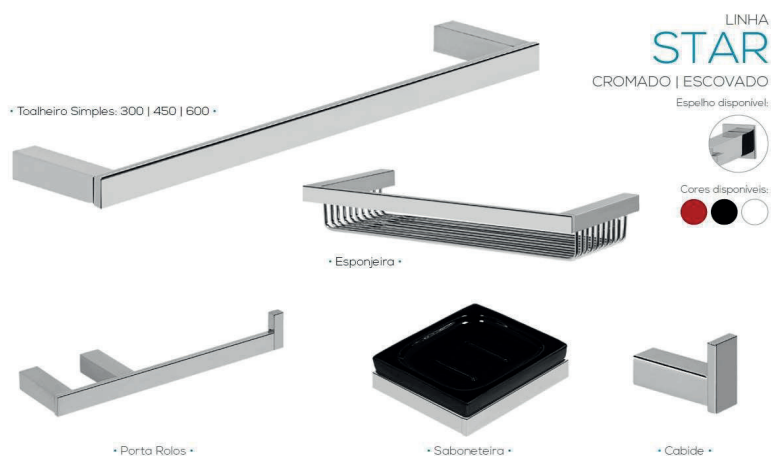

LATÃO CROMO		
CÓDIGO	DESCRIÇÃO	€
05010501	Barra 30cm	<b>30,30</b>
05010502	Barra 40cm	<b>33,10</b>
05010503	Barra 60cm	<b>35,90</b>
05010505	Barra Duplo 40cm	<b>59,40</b>
05010507	Saboneteira	<b>46,50</b>
05010506	Porta Rolo	<b>33,10</b>
05010508	Esponjeira	<b>63,90</b>
05010509	Cabide	<b>20,10</b>

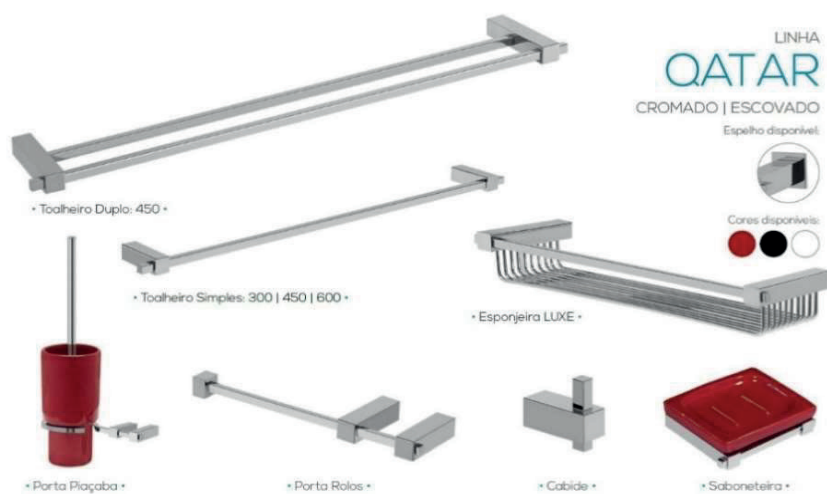

LATÃO CROMO		
CÓDIGO	DESCRIÇÃO	€
05032121	Barra 30cm	<b>28,60</b>
05032122	Barra 40cm	<b>32,10</b>
05032123	Barra 60cm	<b>34,80</b>
05032125	Barra Duplo 40cm	<b>60,20</b>
05032126	Saboneteira	<b>46,50</b>
05032129	Porta Rolo	<b>32,10</b>
05032130	Cabide	<b>19,30</b>

# TOALHEIROS

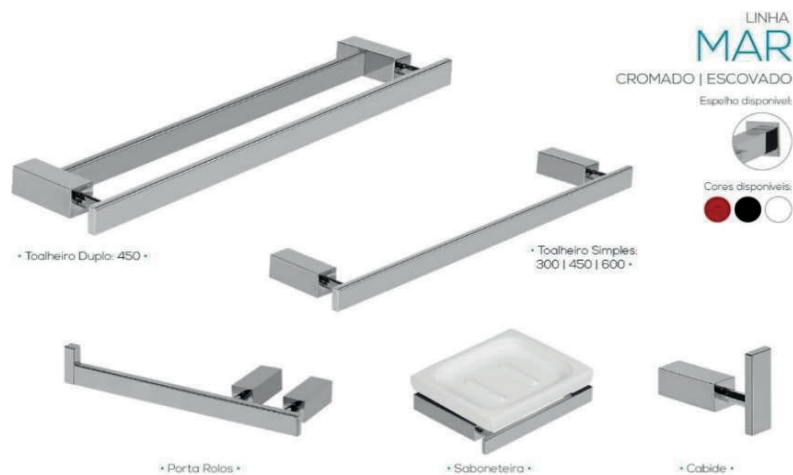

LATÃO CROMO

CÓDIGO	DESCRIÇÃO	€
05032131	Barra 30cm	<b>29,50</b>
05032132	Barra 40cm	<b>33,20</b>
05032133	Barra 60cm	<b>35,90</b>
05032135	Barra Duplo 40cm	<b>60,20</b>
05032136	Saboneteira	<b>46,20</b>
05032139	Porta Rolo	<b>33,20</b>
05032140	Cabide	<b>19,60</b>

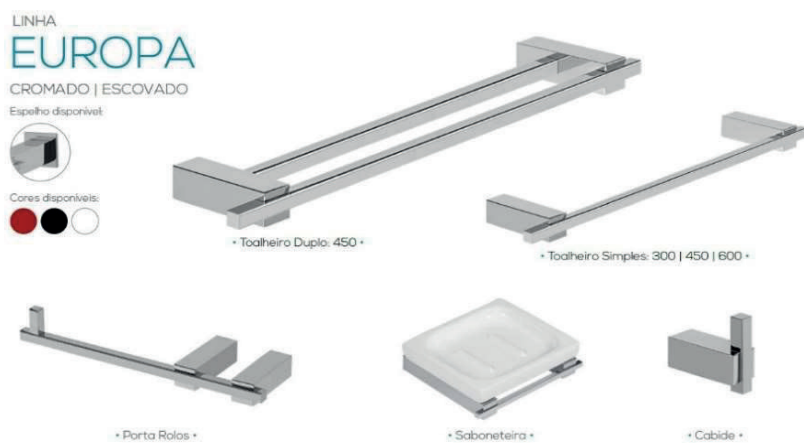

LATÃO CROMO

CÓDIGO	DESCRIÇÃO	€
05032141	Barra 30cm	<b>33,30</b>
05032142	Barra 40cm	<b>36,60</b>
05032143	Barra 60cm	<b>39,20</b>
05032145	Barra Duplo 40cm	<b>68,30</b>
05032146	Saboneteira	<b>52,60</b>
05032149	Porta Rolo	<b>36,60</b>
05032150	Cabide	<b>22,30</b>



LATÃO CROMO

CÓDIGO	DESCRIÇÃO	€
05032151	Barra 30cm	<b>28,60</b>
05032152	Barra 40cm	<b>31,70</b>
05032153	Barra 60cm	<b>35,40</b>
05032155	Barra Duplo 40cm	<b>60,20</b>
05032156	Saboneteira	<b>46,20</b>
05032159	Porta Rolo	<b>31,70</b>
05032160	Cabide	<b>19,30</b>

# TOALHEIROS

## LINHA DOMUS REDONDO

CROMADO | ESCOVADO

Espelhos disponíveis:



Cores disponíveis:



LATÃO CROMO

CÓDIGO	DESCRIÇÃO	€
05032161	Barra 30cm	28,60
05032162	Barra 40cm	31,70
05032163	Barra 60cm	34,40
05032165	Barra Duplo 40cm	60,20
05032166	Saboneteira	46,20
05032169	Porta Rolo	31,70
05032170	Cabide	19,30

## LINHA ALFA LUX

CROMADO | ESCOVADO

Espelho disponível:



Cores disponíveis:



LATÃO CROMO

CÓDIGO	DESCRIÇÃO	€
05032171	Barra 30cm	28,30
05032172	Barra 40cm	32,10
05032173	Barra 60cm	33,50
05032175	Barra Duplo 40cm	56,40
05032176	Saboneteira	45,60
05032179	Porta Rolo	32,10
05032180	Cabide	19,00

## LINHA AQUA

CROMADO | ESCOVADO | INOX

Espelhos disponíveis:



Cores disponíveis:



LATÃO CROMO

CÓDIGO	DESCRIÇÃO	€
05032181	Barra 30cm	22,30
05032182	Barra 40cm	23,60
05032183	Barra 60cm	25,70
05032185	Barra Duplo 40cm	52,00
05032186	Saboneteira	42,50
05032189	Porta Rolo	23,60
05032190	Cabide	19,00

# TOALHEIROS

## LINHA LUSO

CROMADO | ESCOVADO

Espelho disponível:



Cores disponíveis:

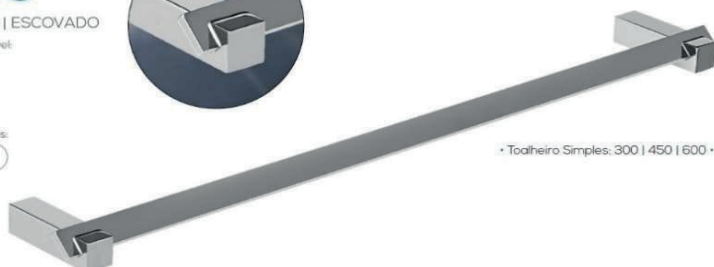
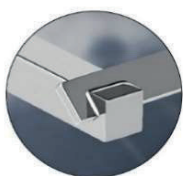

\* Toalheiro Simples: 300 | 450 | 600 \*



\* Porta Rolos \*



\* Saboneteira \*

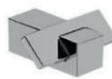

\* Cabide \*

LATÃO CROMO

CÓDIGO	DESCRIÇÃO	€
05032201	Barra 30cm	32,00
05032202	Barra 40cm	36,40
05032204	Barra 60cm	38,70
05032205	Barra Duplo 40cm	67,80
05032206	Saboneteira	52,10
05032209	Porta Rolo	36,40
05032210	Cabide	21,90

## LINHA MARINE

CROMADO | ESCOVADO

Espelho disponível:



Cores disponíveis:



\* Toalheiro Simples: 300 | 450 | 600 \*



\* Porta Rolos \*



\* Toalheiro Duplo Rotativo \*



\* Esponjeira LUXE \*



\* Porta Piaçaba \*



\* Cabide \*

LATÃO CROMO

CÓDIGO	DESCRIÇÃO	€
05032211	Barra 30cm	24,00
05032212	Barra 40cm	25,20
05032213	Barra 60cm	27,30
05032215	Barra Duplo 40cm	56,70
05032216	Saboneteira	44,70
05032218	Porta Rolo	25,20
05032220	Cabide	15,40
05032217	Porta Toalhas 45cm	121,00

## LINHA AVE

CROMADO | ESCOVADO

Espejos disponíveis:



Cores disponíveis:



\* Toalheiro Simples: 450 | 600 \*



\* Saboneteira \*



\* Toalheiro de Argola \*



\* Cabide \*



\* Porta Rolos \*



\* Porta Piaçaba \*

LATÃO CROMO

CÓDIGO	DESCRIÇÃO	€
05032231	Barra 40cm	32,50
05032232	Barra 60cm	35,30
05032234	Argola	35,30
05032235	Barra Duplo 40cm	58,80
05032236	Saboneteira	48,80
05032239	Porta Rolo	36,40
05032240	Cabide	17,40

# TOALHEIROS

## SÉRIE LUNA

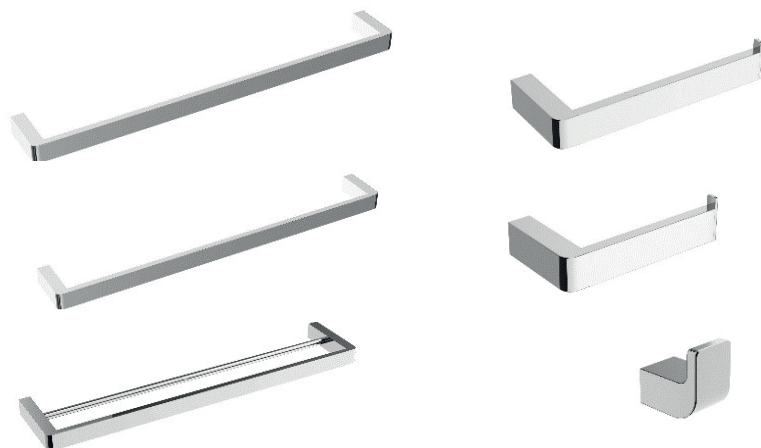

CÓDIGO	DESCRIÇÃO	CROMO €
05010153	BARRA SIMPLES 600	<b>63,00</b>
05010152	BARRA SIMPLES 450	<b>53,20</b>
05010154	BARRA DUPLA 600	<b>86,10</b>
05010151	TOALHEIRO BIDÉ	<b>33,00</b>
05010156	PORTO ROLO	<b>33,00</b>
05010159	CABIDE	<b>12,70</b>

## SÉRIE LUNA

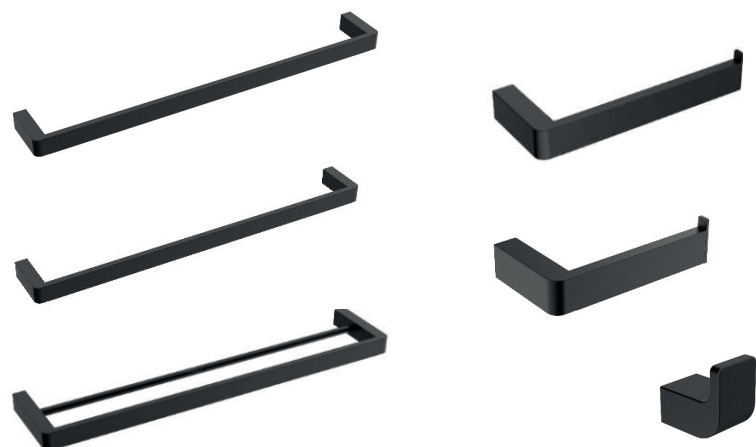

CÓDIGO	DESCRIÇÃO	PRETO €
05010143	BARRA SIMPLES 600	<b>81,00</b>
05010142	BARRA SIMPLES 450	<b>61,00</b>
05010144	BARRA DUPLA 600	<b>101,00</b>
05010141	TOALHEIRO BIDÉ	<b>41,00</b>
05010146	PORTO ROLO	<b>41,00</b>
05010149	CABIDE	<b>14,00</b>

## SÉRIE TH4119



KIT TOALHEIROS 5 PEÇAS

CÓDIGO	ACABAMENTO	€
05020140	CROMO	<b>78,60</b>

### COMPOSIÇÃO:

- » Barra Simples 30cm
- » Barra Simples 45cm
- » Barra Simples 60cm
- » Porta Rolos

# TOALHEIROS

## SÉRIE ANA



KIT TOALHEIROS 5 PEÇAS

CÓDIGO	ACABAMENTO	€
05020324	CROMO	110,00

**COMPOSIÇÃO:**

- » Barra Simples 60cm
- » Barra Simples 50cm
- » Porta Rolos
- » Argola
- » Cabide

## SÉRIE 12000



KIT TOALHEIROS 5 PEÇAS

CÓDIGO	ACABAMENTO	€
05020325	CROMO	113,00

**COMPOSIÇÃO:**

- » Barra Simples 60cm
- » Barra Simples 50cm
- » Barra Simples 30cm
- » Porta Rolos
- » Cabide

## SÉRIE CM010

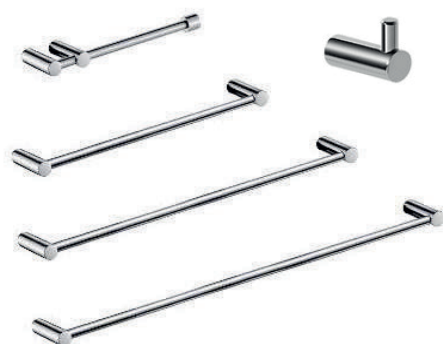

KIT TOALHEIROS 5 PEÇAS

CÓDIGO	ACABAMENTO	€
05020141	CROMO	62,00

**COMPOSIÇÃO:**

- » Barra Simples 55cm
- » Barra Simples 45cm
- » Barra Simples 30cm
- » Porta Rolos
- » Cabide

# TOALHEIROS

## SÉRIE CM022 - CR



KIT TOALHEIROS 5 PEÇAS

CÓDIGO	ACABAMENTO	€
05020143	CROMO	63,00

**COMPOSIÇÃO:**

- » Barra Simples 60cm
- » Barra Simples 50cm
- » Porta Rolos
- » Argola
- » Cabide

## SÉRIE CM010 DOURADO



KIT TOALHEIROS 4 PEÇAS

CÓDIGO	ACABAMENTO	€
05020331	OURO	85,00

**COMPOSIÇÃO:**

- » Barra Simples 60cm
- » Barra Simples 45cm
- » Barra Simples 30cm
- » Porta Rolos

## SÉRIE CM01 BLACK



KIT TOALHEIROS 4 PEÇAS

CÓDIGO	ACABAMENTO	€
05020321	PRETO	60,00

**COMPOSIÇÃO:**

- » Barra Simples 60cm
- » Barra Simples 45cm
- » Barra Simples 30cm
- » Porta Rolos

# TOALHEIROS DE PÉ

## R10

TOALHEIRO DE PÉ LATÃO CROMADO



CÓDIGO	ACABAM.	€
06010304	CROMO	135,60

## R11

TOALHEIRO DE PÉ LATÃO CROMADO



CÓDIGO	ACABAM.	€
06010216	CROMO	152,00

## R30

TOALHEIRO DE PÉ LATÃO CROMADO



CÓDIGO	ACABAM.	€
06010305	CROMO	110,90

## R31

TOALHEIRO DE PÉ LATÃO CROMADO



CÓDIGO	ACABAM.	€
06010215	CROMO	126,60

## Q20

TOALHEIRO DE PÉ LATÃO CROMADO



CÓDIGO	ACABAM.	€
06010204	CROMO	158,00

## Q21

TOALHEIRO DE PÉ LATÃO CROMADO



CÓDIGO	ACABAM.	€
06010214	CROMO	174,80

## Q40

TOALHEIRO DE PÉ LATÃO CROMADO



CÓDIGO	ACABAM.	€
06010203	CROMO	110,90

## Q41

TOALHEIRO DE PÉ



CÓDIGO	ACABAM.	€
06010213	CROMO	126,60

## R50

TOALHEIRO DE PÉ



CÓDIGO	ACABAM.	€
06010303	CROMO	121,00

## TOALHEIROS DE PÉ

### R51

TOALHEIRO DE PÉ



CÓDIGO	ACABAM.	€
06010212	CROMO	136,70

### R70

TOALHEIRO DE PÉ

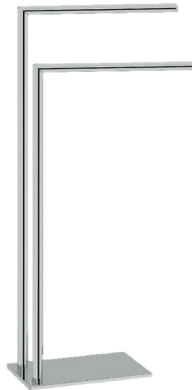

CÓDIGO	ACABAM.	€
06010205	CROMO	128,80

### R71

TOALHEIRO DE PÉ



CÓDIGO	ACABAM.	€
06010206	CROMO	136,70

## PORTA PIAÇABAS - PORTA ROLOS - BALDES

### TH-118

PORTA PIAÇABA



CÓDIGO	ACAB.	€
05100116	LATÃO CROM.	44,30

### TH-119

PORTA PIAÇABA



CÓDIGO	ACAB.	€
05100124	LATÃO CROM.	45,00

### RF. 4000

PORTA PIAÇABA



CÓDIGO	ACAB.	€
05040614	INOX	36,80

### 9012

PORTA PIAÇABA



CÓDIGO	ACAB.	€
05040610	INOX	12,00

### QUADRADO

BALDE INOX WX C/ TAMPA E PEDAL



CÓDIGO	CAPACIDADE	€
05035611	3 Lt.	20,00
05035612	5 Lt.	26,00
05035613	12 Lt.	40,00

### REDONDO

BALDE INOX WX C/ TAMPA E PEDAL



CÓDIGO	CAPACIDADE	€
05035601	3 Lt.	12,30
05035602	5 Lt.	13,30
05035603	12 Lt.	28,60

## SABONETEIRAS - ESPONJEIRAS - PORTA ROLO

**8015**

SABONETEIRA



CÓDIGO	ACAB.	€
05035402	230x105x35	<b>23,20</b>

**TH15S**

SABONETEIRA



CÓDIGO	ACAB.	€
05035428	135x90x35	<b>17,00</b>

**8011**

SABONETEIRA



CÓDIGO	ACAB.	€
05035403	230x105x35	<b>26,40</b>

**73390**

SABONETEIRA



CÓDIGO	ACAB.	€
05035404	245x190x60	<b>28,50</b>

**8014CP**

SABONETEIRA



CÓDIGO	ACAB.	€
05035412	250x120x50	<b>26,40</b>

**TH16S**

SABONETEIRA



CÓDIGO	ACAB.	€
05035434	150x90x35	<b>18,00</b>

**73393**

SABONETEIRA



CÓDIGO	ACAB.	€
05035405	245x350x60	<b>53,00</b>

**TH09S**

SABONETEIRA



CÓDIGO	ACAB.	€
05035399	350x245x60	<b>59,00</b>

**81807**

PORTA ROLO INOX C/ TAMPA



CÓDIGO	ACAB.	€
05100201	INOX	<b>18,50</b>





# SEPARADOR

## 6

- LAVA LOIÇAS EM PEDRA ARTIFICIAL
- LAVA LOIÇAS INOX



# LAGA LOIÇA EM PEDRA ARTIFICIAL

## SEF5544

PIO SIMPLES ENCASTRAR

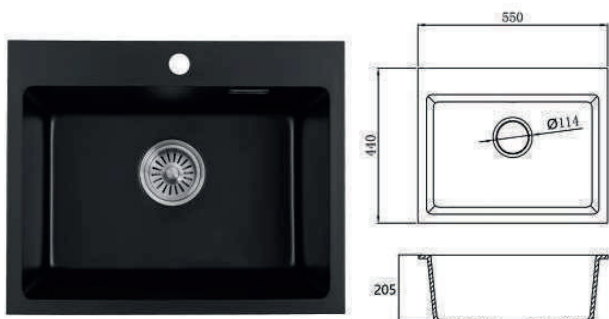

CÓDIGO	MEDIDAS	€
25020251	550x440x205	316,00

## SEF5648

PIO SIMPLES ENCASTRAR

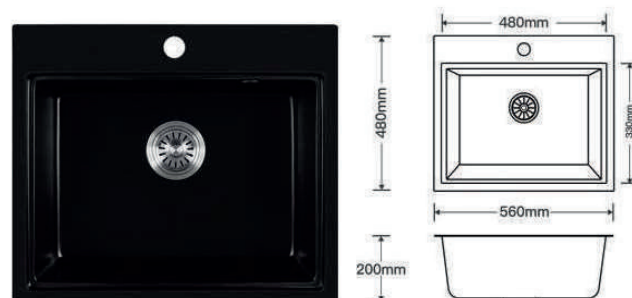

CÓDIGO	MEDIDAS	€
25020256	560x480x200	316,00

## SEF6449

PIO SIMPLES ENCASTRAR

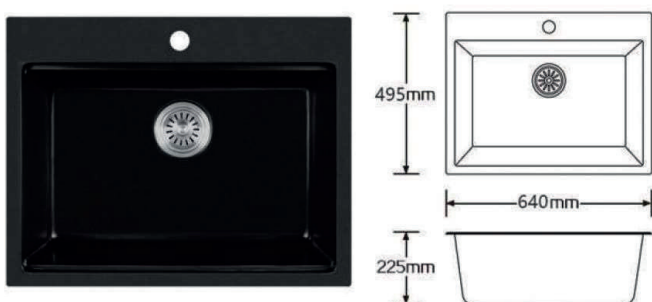

CÓDIGO	MEDIDAS	€
25020266	640x495x225	342,00

## SEF7747

PIO SIMPLES ENCASTRAR

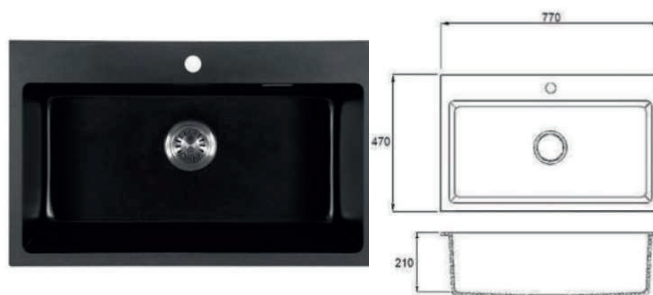

CÓDIGO	MEDIDAS	€
25020296	770x470x210	374,00

## SE3944

PIO SIMPLES ENCASTRAR

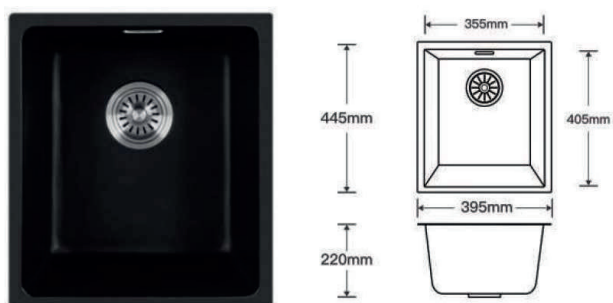

CÓDIGO	MEDIDAS	€
25020206	395x445x220	279,00

## SE5443

PIO SIMPLES ENCASTRAR

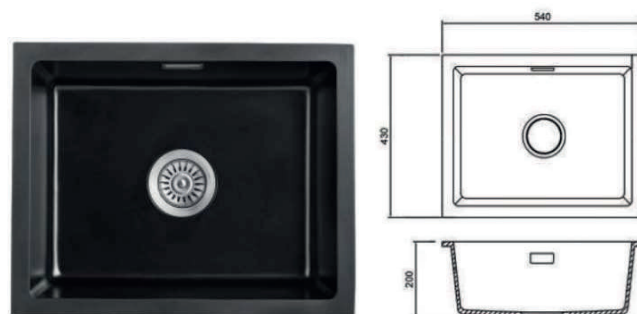

CÓDIGO	MEDIDAS	€
25020226	540x430x200	300,00

# LAVA LOIÇA EM PEDRA ARTIFICIAL

## SE5644

PIO SIMPLES ENCASTRAR



CÓDIGO	MEDIDAS	€
25020211	560x445x210	322,00

## SE6843

PIO SIMPLES ENCASTRAR



CÓDIGO	MEDIDAS	€
25020216	680x430x230	337,00

## DSF8346

PIO SIMPLES ENCASTRAR

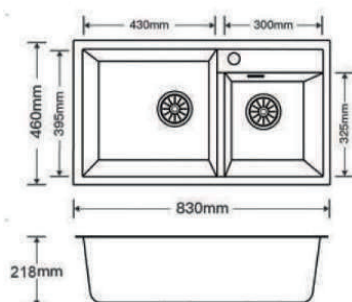

CÓDIGO	MEDIDAS	€
25020331	830x460x218	390,00

## DSF8648

PIO SIMPLES ENCASTRAR

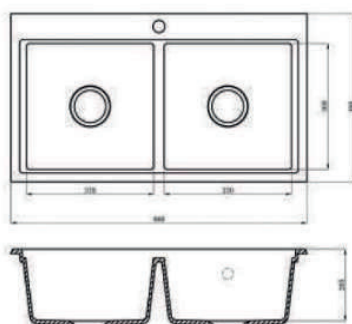

CÓDIGO	MEDIDAS	€
25020351	860x480x205	421,00

## DEF10050

PIO SIMPLES ENCASTRAR

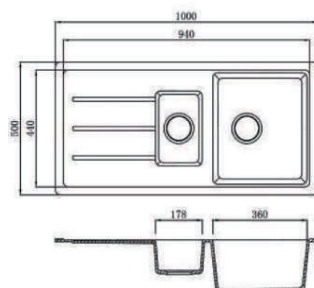

CÓDIGO	MEDIDAS	€
25020406	1000x500x200	516,00

# LAVA LOIÇA EM PEDRA ARTIFICIAL

## DEF12050

PIO SIMPLES ENCASTRAR

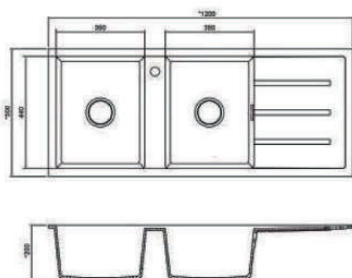

CÓDIGO	MEDIDAS	€
25020411	1200x500x200	526,00

## DE8446

PIO SIMPLES ENCASTRAR

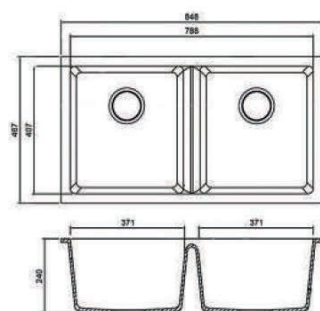

CÓDIGO	MEDIDAS	€
25020361	848x467x240	421,00

## SE10050

PIO SIMPLES ENCASTRAR

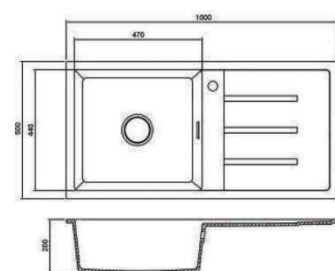

CÓDIGO	MEDIDAS	€
25020401	1000x500x200	432,00

RESISTENTE A TEMPERATURA ATÉ 280°

RESISTENTE AOS RISCOS

RESISTENTE PRODUTOS ABRASIVOS

# LAVA LOIÇAS INOX

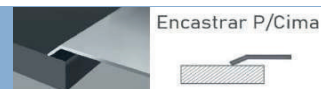

## DQ10050

LAVA LOIÇA ENCASTRAR 1PIO E 1/2 + ESCORREDOURO

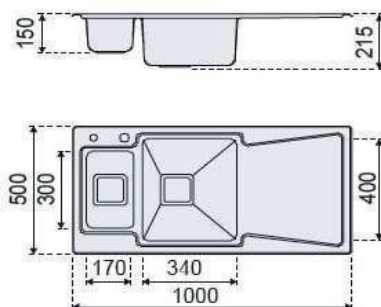

CÓDIGO	MEDIDAS	€
25010582	1000X500	383,00

## DQ11650

LAVA LOIÇA ENCASTRAR 2 PIOS + ESCORREDOURO

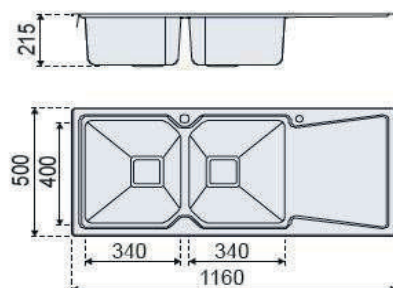

CÓDIGO	MEDIDAS	€
25010583	1160X500	486,00

## SQ8650

LAVA LOIÇA ENCASTRAR 1 PIO + ESCORREDOURO

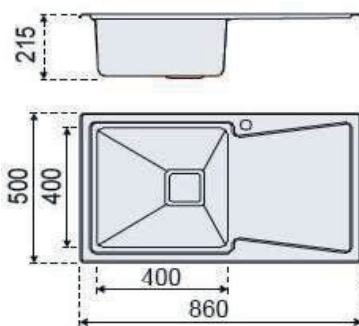

CÓDIGO	MEDIDAS	€
25010584	860X500	300,00

## DE9750B

LAVA LOIÇA ENCASTRAR 1PIO E 1/2 + ESCORREDOURO

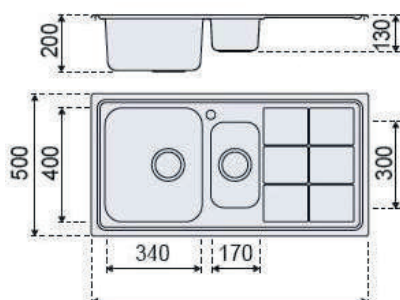

CÓDIGO	MEDIDAS	€
25010623	970X500	231,00

# LAVA LOIÇAS INOX

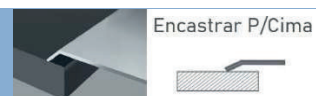

## SE8650

LAVA LOIÇA ENCASTRAR 1PIO + ESCORREDOURO

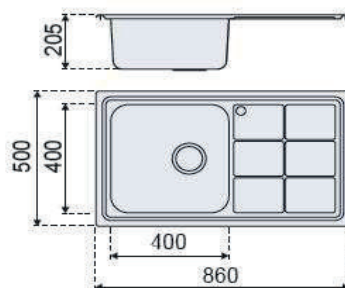

CÓDIGO	MEDIDAS	€
25010621	860X500	193,00

## DE12050

LAVA LOIÇA ENCASTRAR

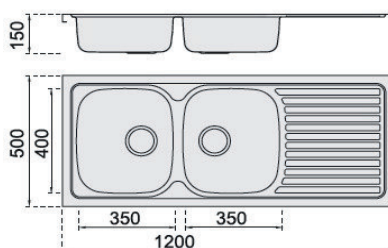

CÓDIGO	MEDIDAS	€
25010524	1200X500	145,00

## DE8048

LAVA LOIÇA ENCASTRAR 2 PIOS

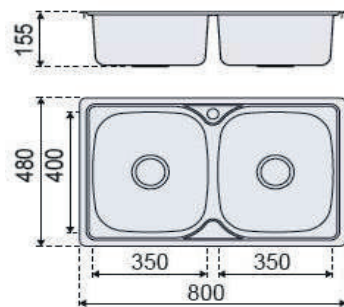

CÓDIGO	MEDIDAS	€
25010521	800X480	134,00

## SE8048

LAVA LOIÇA ENCASTRAR 1PIO + ESCORREDOURO

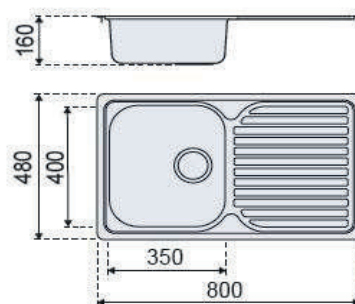

CÓDIGO	MEDIDAS	€
25010518	800X480	100,00

# LAVA LOIÇAS INOX

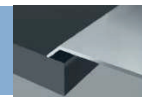

Encastrar P/Cima

## SE8044

LAVA LOIÇA ENCASTRAR 1PIO + ESCORREDOURO

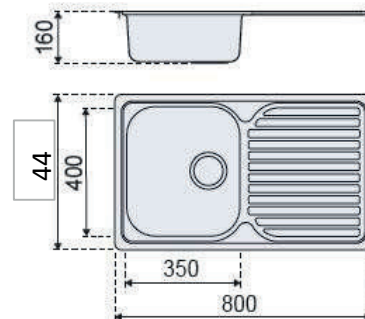

CÓDIGO	MEDIDAS	€
25010517	800X440	100,00

## DE8444

DUETO ENCASTRAR 2 PIOS

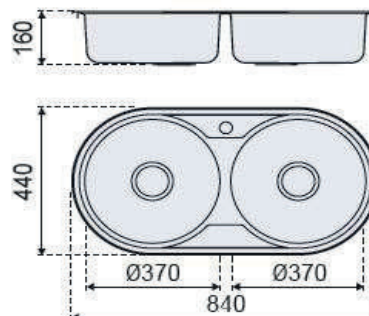

CÓDIGO	MEDIDAS	€
25010305	840X440	134,00

## SE8444

SEMI DUETO ENCASTRAR 1 PIO + ESCORREDOURO

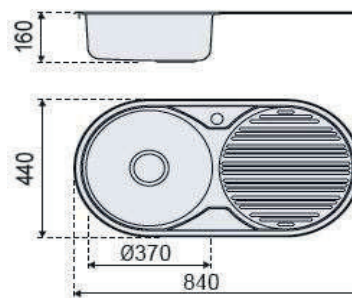

CÓDIGO	MEDIDAS	€
25010309	840X440	103,00

# LAVA LOIÇAS INOX

## SE4949

PIO SIMPLES ENCASTRAR P/ CIMA

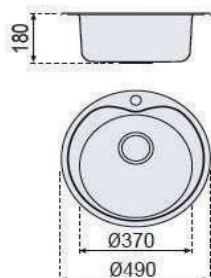

CÓDIGO	MEDIDAS	€
25010268	Ø 370	72,00

## SE4545

PIO SIMPLES ENCASTRAR P/ CIMA

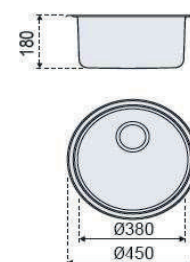

CÓDIGO	MEDIDAS	€
25010267	Ø 450	65,00

## SE5050

PIO SIMPLES ENCASTRAR P/ CIMA

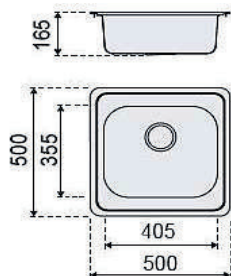

CÓDIGO	MEDIDAS	€
25010266	500X500	75,00

## SE3838

PIO SIMPLES ENCASTRAR P/ CIMA

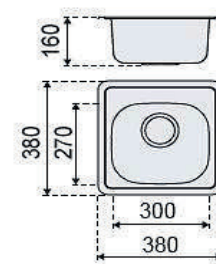

CÓDIGO	MEDIDAS	€
25010265	380X380	49,40

## SU4545 R15

PIO SIMPLES ENCASTRAR P/ BAIXO

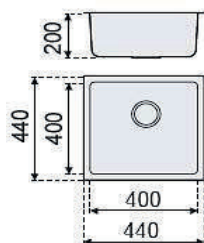

CÓDIGO	MEDIDAS	€
25010285	440X440	133,00

## SU5045 R15

PIO SIMPLES ENCASTRAR P/ BAIXO

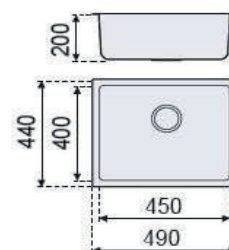

CÓDIGO	MEDIDAS	€
25010287	490X440	143,00

# LAVA LOIÇAS INOX

## SU5545 R15

PIO SIMPLES ENCASTRAR P/ BAIXO

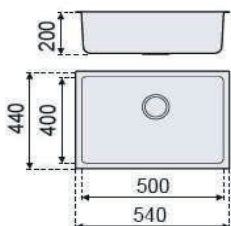

CÓDIGO	MEDIDAS	€
25010297	540X440	152,00

## SU7240 - R15

PIO SIMPLES ENCASTRAR P/ BAIXO

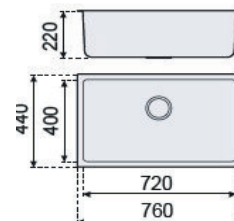

CÓDIGO	MEDIDAS	€
25010299	760x440	225,00

## SE16755

PIO ENCASTRAR P/ CIMA C/ FURO P/ TORNEIRA

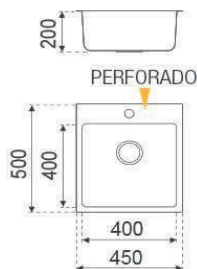

CÓDIGO	MEDIDAS	€
25010351	500X450	209,00

## SE16756

PIO ENCASTRAR P/ CIMA C/ FURO P/ TORNEIRA



CÓDIGO	MEDIDAS	€
25010352	500X500	238,00

## SE16757

PIO ENCASTRAR P/ CIMA C/ FURO P/ TORNEIRA

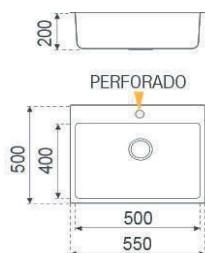

CÓDIGO	MEDIDAS	€
25010353	500X550	253,00

## S16766

ESCUREDOURO INOX

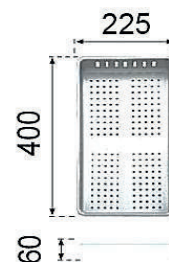

CÓDIGO	MEDIDAS	€
25010269	400X225	46,00

# LAVA LOIÇAS INOX

## SU4540

PIO SIMPLES ENCASTRAR

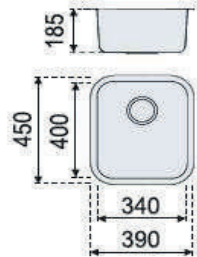

\*encastrar p/ baixo

CÓDIGO	MEDIDAS	€
25010282	450X390	101,00

## SU4545

PIO SIMPLES ENCASTRAR

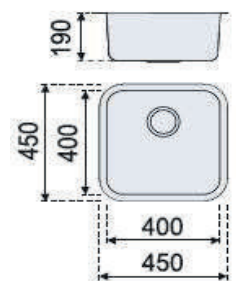

CÓDIGO	MEDIDAS	€
25010294	450X450	104,00

## SU5045

PIO SIMPLES ENCASTRAR

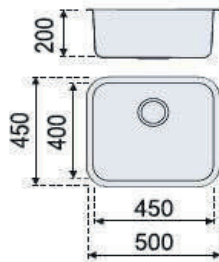

CÓDIGO	MEDIDAS	€
25010295	500X450	120,00

## SU5545

PIO SIMPLES ENCASTRAR

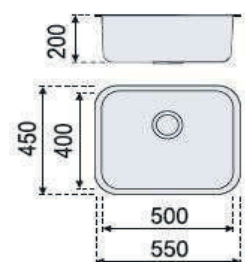

CÓDIGO	MEDIDAS	€
25010296	550X450	128,00

## SU4545 - preto

PIO SIMPLES ENCASTRAR

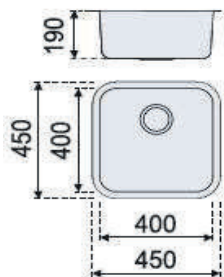

CÓDIGO	MEDIDAS	€
25010214	450x450	135,00
válvula preta -		21,30€

## SU5045 - preto

PIO SIMPLES ENCASTRAR

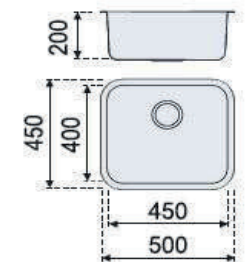

CÓDIGO	MEDIDAS	€
25010215	500x450	153,00
válvula preta -		21,30€

# LAVA LOIÇAS INOX

## SU5545 - preto

PIO SIMPLES ENCASTRAR

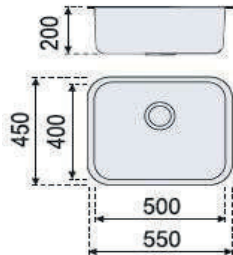

CÓDIGO	MEDIDAS	€
25010216	550x450	160,00

válvula preta - 21,30€

## SU4545 R15 - preto

PIO SIMPLES ENCASTRAR

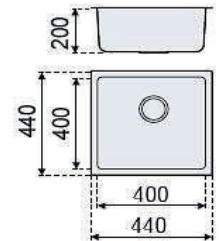

CÓDIGO	MEDIDAS	€
25010210	450x450	152,00

válvula preta - 21,30€

## SU5045 R15 - preto

PIO SIMPLES ENCASTRAR

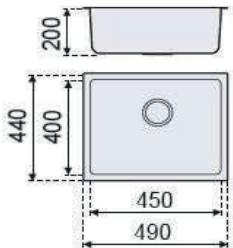

CÓDIGO	MEDIDAS	€
25010211	500x450	162,00

válvula preta - 21,30€

## SU5545 R15 - preto

PIO SIMPLES ENCASTRAR

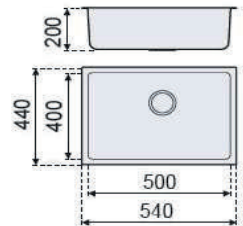

CÓDIGO	MEDIDAS	€
25010212	550x450	172,00

válvula preta - 21,30€

## DIGI7545 PRETO

PIO ENCASTRAR C/TORNEIRA E CHUVEIRO



CÓDIGO	MEDIDAS	€
25030103	750x450x220	420,00

## DIGI7545 OURO

PIO ENCASTRAR C/TORNEIRA E CHUVEIRO

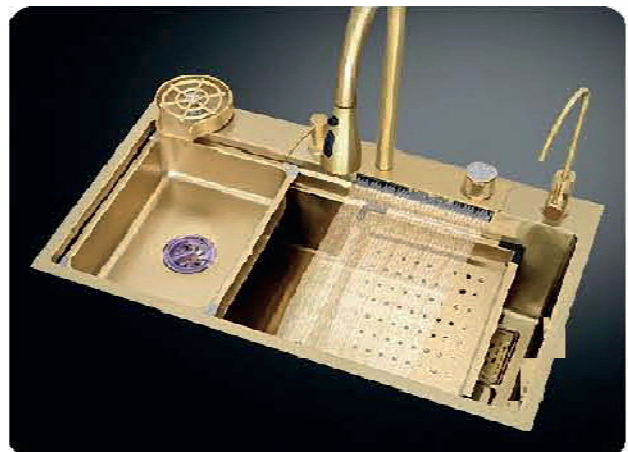

CÓDIGO	MEDIDAS	€
25030111	750x450x220	590,00

# LAVA LOIÇAS INOX

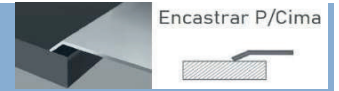

## MEZZO LIGHT

LAVA LOIÇA ENCASTRAR 1 PIO C/ ESCORREDOURO

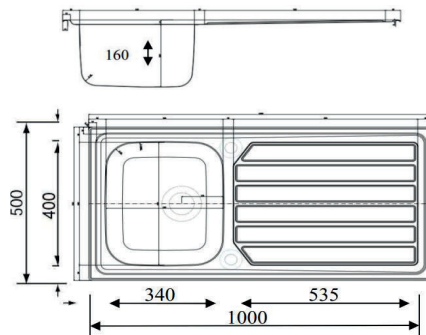

CÓDIGO	MEDIDAS	€
25010236	800x500x160	104,00
25010238	100x500x160	121,00

## MEZZO

LAVA LOIÇA ENCASTRAR 1 PIO C/ ESCORREDOURO

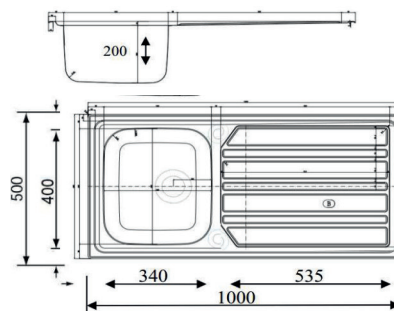

CÓDIGO	MEDIDAS	€
25010246	800x500x200	200,00
25010248	1000x500x200	240,00

## MEZZO LIGHT DUPLO

LAVA LOIÇA ENCASTRAR 2 PIOS

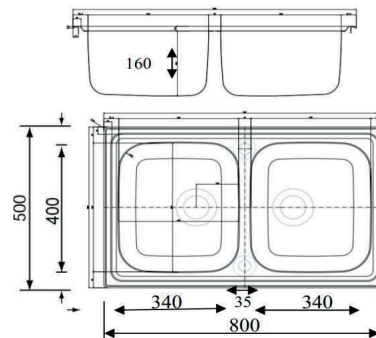
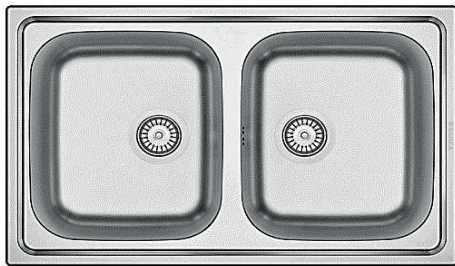

CÓDIGO	MEDIDAS	€
25010231	800x500x160	123,00

## MEZZO DUPLO

LAVA LOIÇA ENCASTRAR 2 PIOS

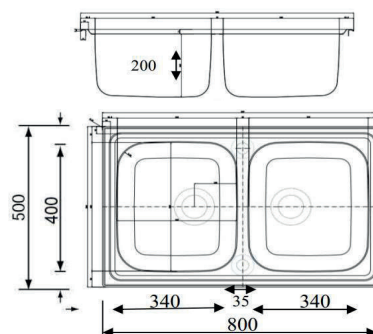

CÓDIGO	MEDIDAS	€
25010241	800x500x200	283,00

# LAVA LOIÇAS INOX

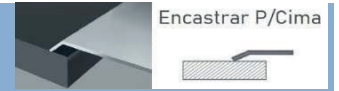

## MEZZO LIGHT 2P+ESC

LAVA LOIÇA ENCASTRAR 2 PIOS C/ ESCORREDOURO

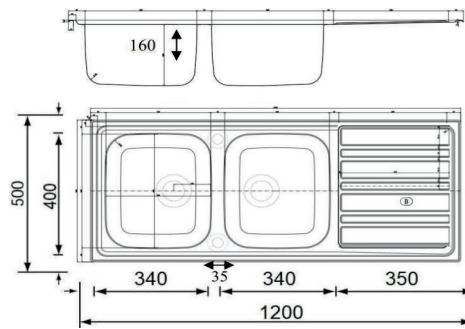
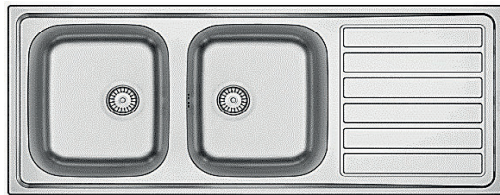

CÓDIGO	MEDIDAS	€
25010233	1200x500x160	156,00

## MEZZO 2 P+ESC

LAVA LOIÇA ENCASTRAR 2 PIOS C/ ESCORREDOURO

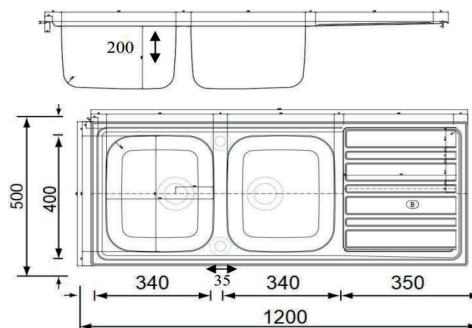
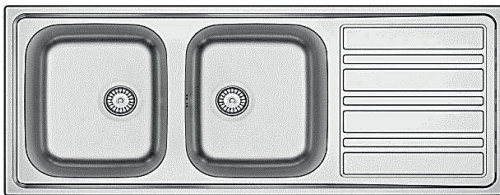

CÓDIGO	MEDIDAS	€
25010243	1200x500x200	273,00

## MEZZO LIGHT 1P+1/2

LAVA LOIÇA ENCASTRAR 1 PIO 1/2 C/ ESCORREDOURO

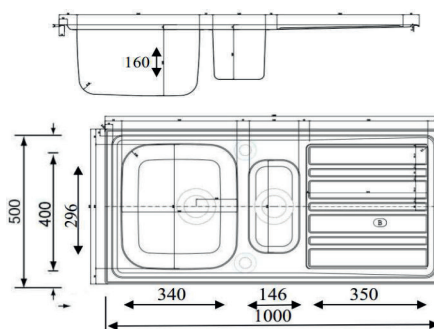

CÓDIGO	MEDIDAS	€
25010234	1000x500x160	177,00

## MEZZO 1P+1/2

LAVA LOIÇA ENCASTRAR 1PIO E 1/2 + ESCORREDOURO

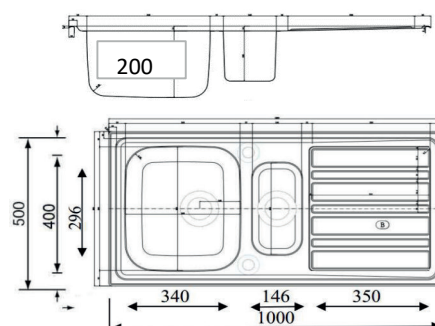

CÓDIGO	MEDIDAS	€
25010244	1000x500x200	260,00

# LAVA LOIÇAS INOX

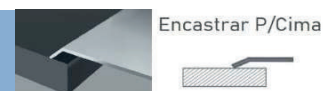

## M1000

LAVA LOIÇA POU SAR 1 PIO C/ ESCORREDOURO

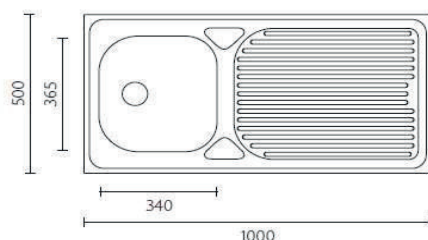
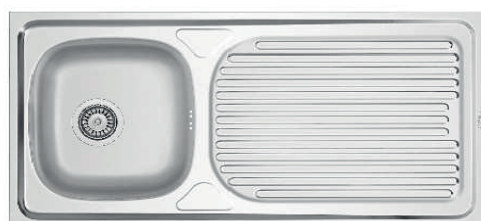

CÓDIGO	MEDIDAS	€
25010101	800x500x150	95,00
25010102	900x500x150	105,00
25010103	1000x500x150	112,00
25010121	800x600x150	107,00
25010122	900x600x150	110,00
25010123	1000x600x150	118,00

## M3000

LAVA LOIÇA POU SAR 2 PIOS C/ ESCORREDOURO

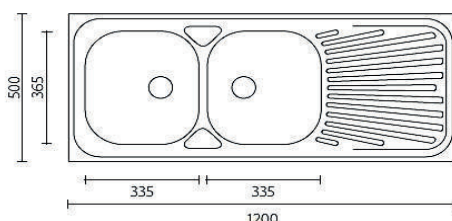

CÓDIGO	MEDIDAS	€
25010201	1200x500x150	135,00
25010202	1300x500x150	156,00
25010204	1400x500x150	171,00
25010221	1200x600x150	137,00
25010222	1300x600x150	175,00
25010224	1400x600x150	194,00

## M6000

DUETO ENCASTRAR 2 PIOS

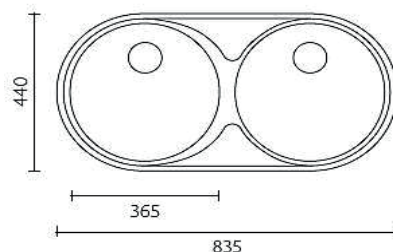

CÓDIGO	MEDIDAS	€
25010303	835x440x150	127,00

## M7000

SEMI DUETO ENCASTRAR 1 PIO + 1 ESCORREDOURO

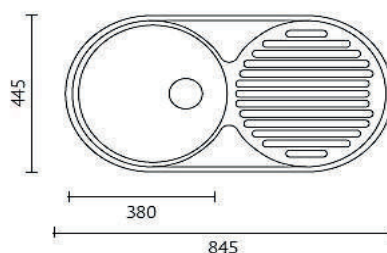
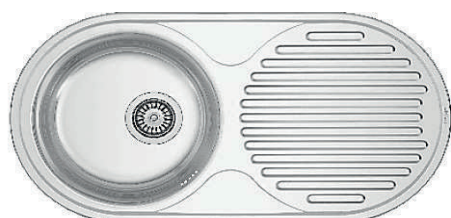

CÓDIGO	MEDIDAS	€
25010311	845x445x150	119,00

# LAVA LOIÇAS INOX



## M10000

2 PIOS ENCASTRAR

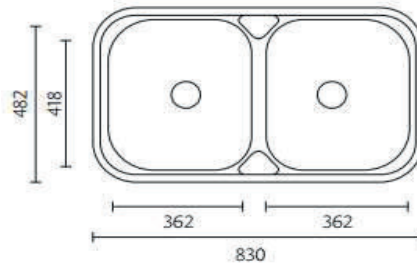

CÓDIGO	MEDIDAS	€
25010326	830x482x150	147,00

## M11000

LAVA LOIÇA ENCASTRAR 1 PIO C/ ESCOREDOURO

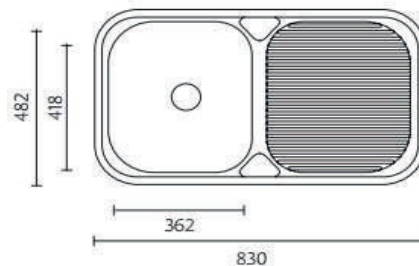

CÓDIGO	MEDIDAS	€
25010331	830x482x150	131,00

## M4000/ M19000

PIO ENCASTRAR QUADRADO

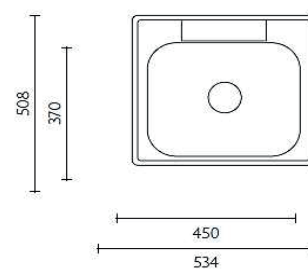

CÓDIGO	MEDIDAS	€
25010261	500x580x150	88,50

## M5000

PIO SIMPLES ENCASTRAR

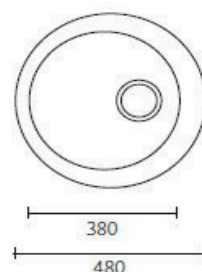

CÓDIGO	MEDIDAS	€
25010292	480x160	104,00

# LAVA LOIÇAS INOX

Encastrar P/Cima

## M8000/8160

PIO ENCASTRAR REDONDO



CÓDIGO	MEDIDAS	€
25012408	450x160	91,00

## M12000

PIO ENCASTRAR QUADRADO



CÓDIGO	MEDIDAS	€
24010411	381x381x178	89,00

## U24000/IBERICO 34

PIO ENCASTRAR P/ BAIXO

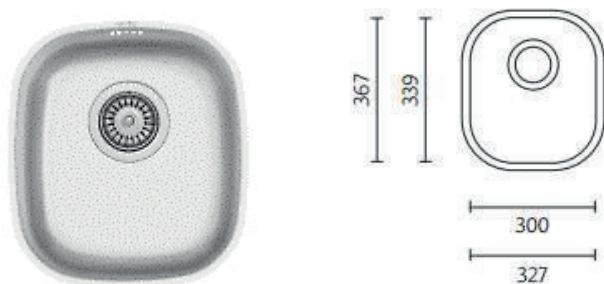

CÓDIGO	MEDIDAS	€
25010423	339x300x160	142,00

## MU25000/ IBERICO 40

PIO ENCASTRAR P/ BAIXO

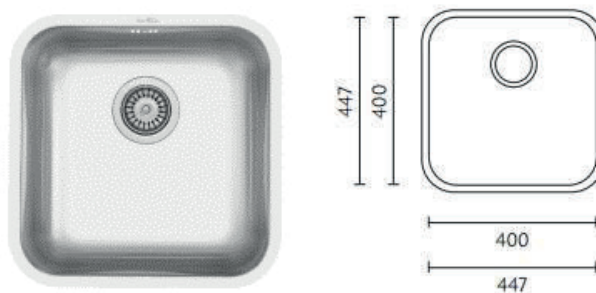

CÓDIGO	MEDIDAS	€
25010426	447x447x160	148,00
25010427	447x447x200	159,00

## U12000/ IBÉRICO 45

PIO ENCASTRAR P/ BAIXO

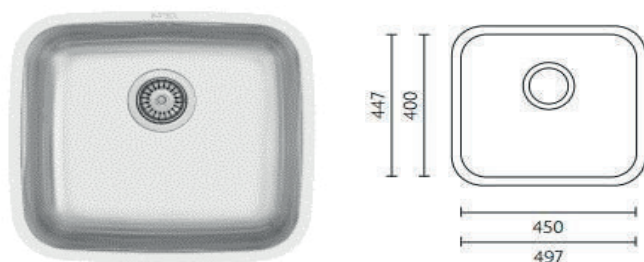

CÓDIGO	MEDIDAS	€
25010418	450x400x160	161,00

## IBÉRICO 50

PIO ENCASTRAR P/ BAIXO

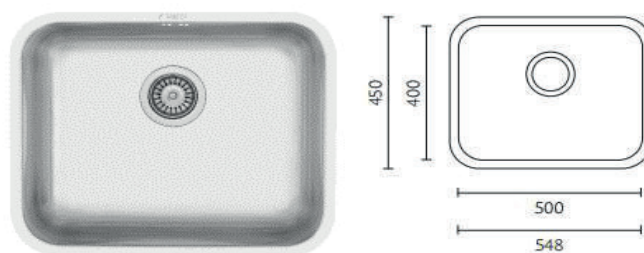

CÓDIGO	MEDIDAS	€
25010424	548x450x160	173,00



# SEPARADOR

## 7

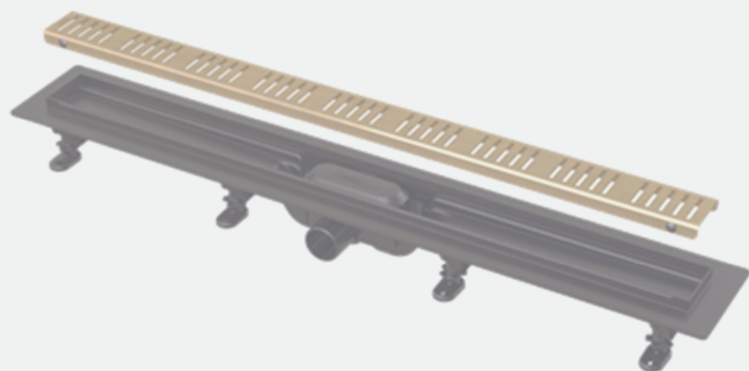

- CALEIRAS
- GRELHAS
- SUMIDOUROS PARA DUCHE
- AUTOCLISMOS
- PLACAS DE DESCARGA
- MECANISMOS PARA LOIÇAS SANITÁRIAS
- VALVULAS
- SIFÕES
- CALÇÕES



# CALEIRA P/ DUCHE

## APZ101 BLACK

CALEIRA INOX P/ DUCHE ENCASTRAR PAVIMENTO

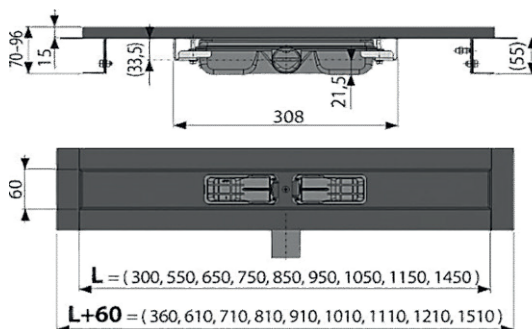

CÓDIGO	MEDIDA	€
24070143	300	187,00
24070144	550	247,00
24070145	650	263,00
24070146	750	279,00
24070147	850	295,00
24070148	950	311,00
24070149	1050	327,00
24070150	1150	330,00

## APZ101 LOW

CALEIRA INOX P/ DUCHE ENCASTRAR PAVIMENTO

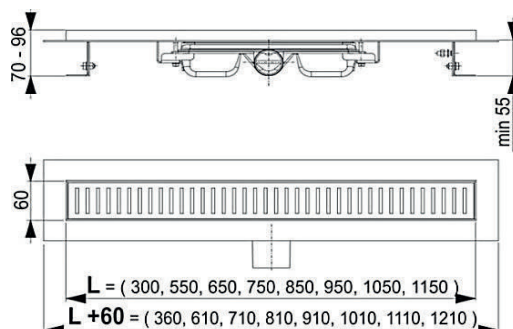

CÓDIGO	MEDIDA	€
24070123	300	174,00
24070124	550	235,00
24070125	650	247,00
24070126	750	264,00
24070127	850	276,00
24070128	950	292,00
24070129	1050	312,00
24070130	1150	327,00

## APZ104 LOW

CALEIRA INOX P/ DUCHE ENCASTRAR PAVIMENTO/PAREDE

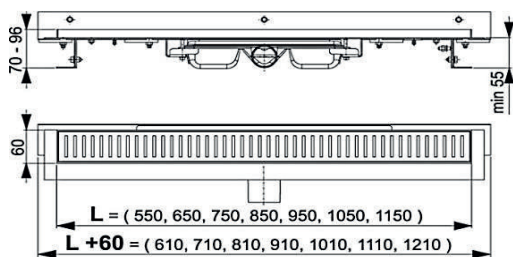

CÓDIGO	MEDIDA	€
24070424	550	273,00
24070425	650	289,00
24070426	750	305,00
24070427	850	321,00
24070428	950	340,00
24070429	1050	360,00
24070420	1150	381,00

## APZ106 LOW

CALEIRA INOX P/ DUCHE ENCASTRAR PAVIMENTO

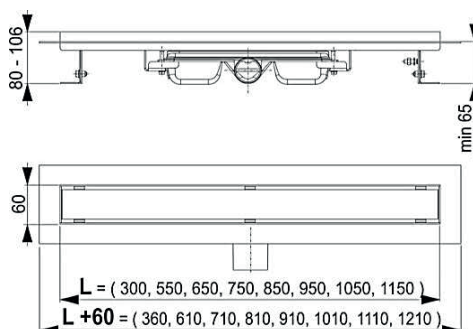

CÓDIGO	MEDIDA	€
24070623	550	276,00
24070624	650	292,00
24070625	750	311,00
24070626	850	327,00
24070627	950	346,00
24070628	1050	365,00
24070629	1150	391,00

# CALEIRA P/ DUCHE

## APZ16

CALEIRA INOX P/ DUCHE ENCASTRAR PAVIMENTO/PAREDE

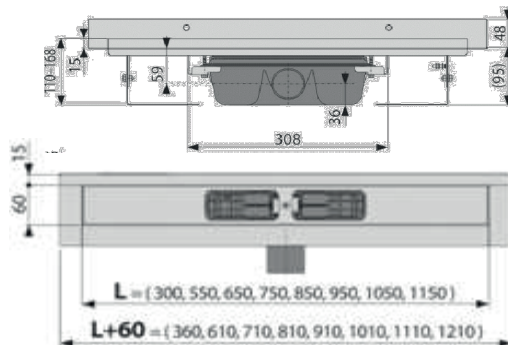
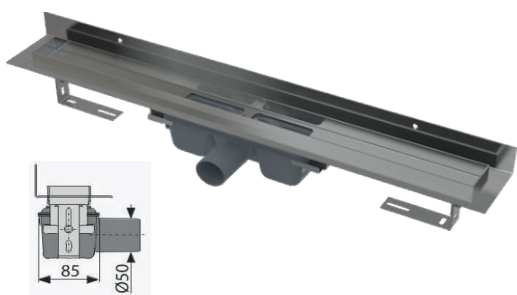

CÓDIGO	MEDIDA	€
24070612	300	257,00
24070613	550	276,00
24070614	650	292,00
24070615	750	311,00
24070616	850	327,00
24070617	950	346,00
24070618	1050	362,00
24070619	1150	391,00

## APZ116

CALEIRA INOX P/ DUCHE ENCASTRAR PAVIMENTO/PAREDE

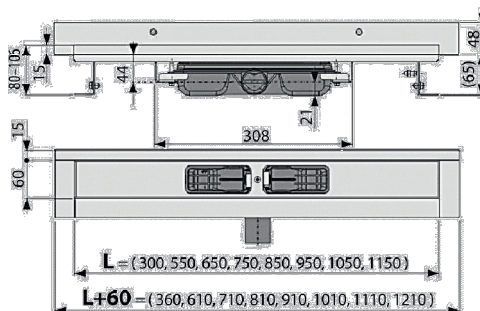

CÓDIGO	MEDIDA	€
24070633	550	257,00
24070634	650	276,00
24070635	750	292,00
24070636	850	311,00
24070637	950	327,00
24070638	1050	346,00
24070639	1150	362,00

## APZ15

CALEIRA INOX P/ DUCHE ENCASTRAR PAVIMENTO COM GRELHA

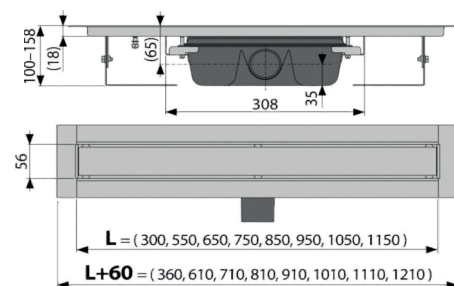
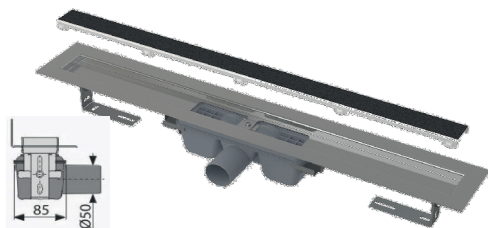

» Grelha p/ acabam. Em pedra ou mármore

CÓDIGO	MEDIDA	€
24070203	300	260,00
24070204	550	280,00
24070205	650	295,00
24070206	750	318,00
24070207	850	334,00
24070208	950	353,00
24070209	1050	372,00
24070210	1150	397,00

## APZ115

CALEIRA INOX P/ DUCHE ENCASTRAR PAVIMENTO COM GRELHA

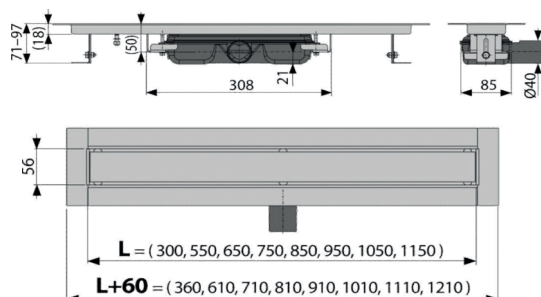
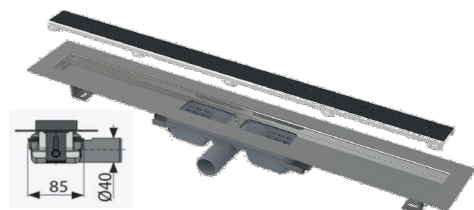

» Grelha p/ acabam. Em pedra ou mármore

CÓDIGO	MEDIDA	€
24070213	300	260,00
24070214	550	280,00
24070215	650	295,00
24070216	750	318,00
24070217	850	334,00
24070218	950	353,00
24070220	1050	372,00
24070219	1150	397,00

# CALEIRA P/ DUCHE

## APZ9

CALEIRA PP C/ GRELHA INOX ENCASTRAR PAVIMENTO

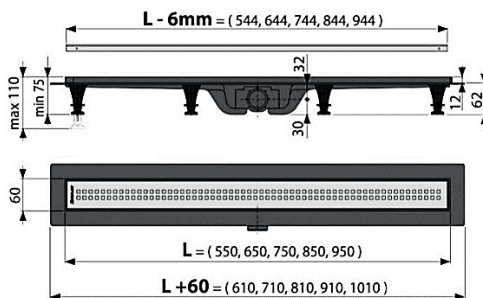

CÓDIGO	MEDIDA	€
24070903	550	108,00
24070904	650	118,00
24070905	750	127,00
24070906	850	137,00
24070907	950	146,00

## APZ10

CALEIRA PP C/ GRELHA INOX ENCASTRAR PAVIMENTO

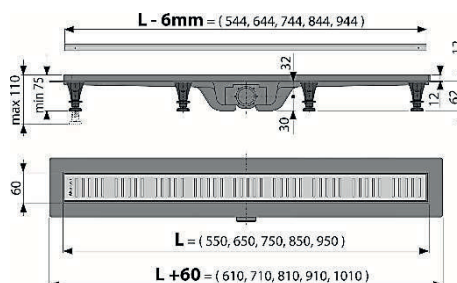
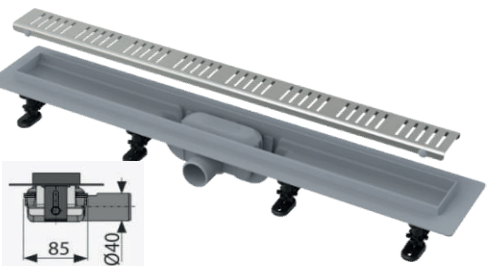

CÓDIGO	MEDIDA	€
24070923	550	108,00
24070924	650	118,00
24070925	750	127,00
24070926	850	137,00
24070927	950	146,00

## APZ10 BLACK

CALEIRA PP C/ GRELHA INOX ENCASTRAR PAVIMENTO

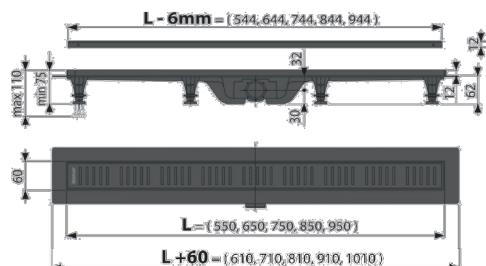
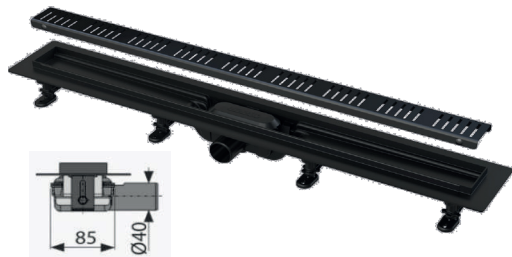

CÓDIGO	MEDIDA	€
24070933	550	128,00
24070934	650	140,00
24070935	750	150,00
24070936	850	160,00
24070937	950	170,00

## APZ10 BLACK BRASS

CALEIRA PP C/ GRELHA INOX ENCASTRAR PAVIMENTO

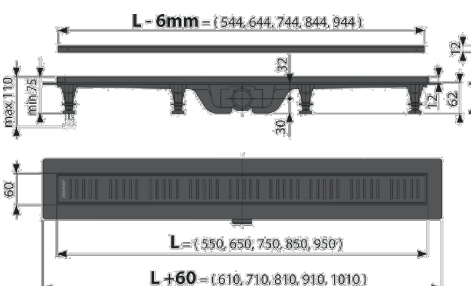

CÓDIGO	MEDIDA	€
24040843	550	128,00
24070844	650	140,00
24070845	750	150,00
24070946	850	160,00
24070847	950	170,00

# CALEIRA P/ DUCHE

## APZ12

CALEIRA PP PARA ENCASTRAR PAVIMENTO

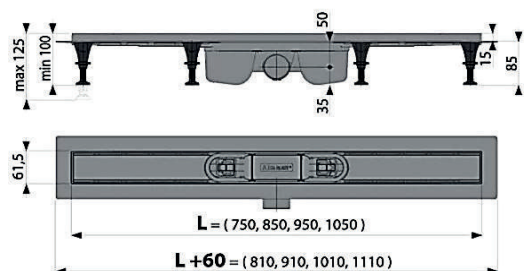

CÓDIGO	MEDIDA	€
24070943	550	160,00
24070944	650	170,00
24070945	750	182,80
24070946	850	196,00
24070947	950	210,00
24070948	1050	222,00

## APZ18

CALEIRA PP PARA ENCASTRAR PAVIMENTO C/ GRELHA

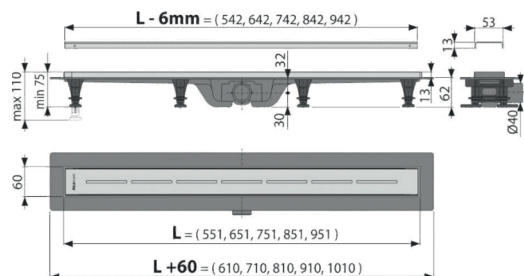
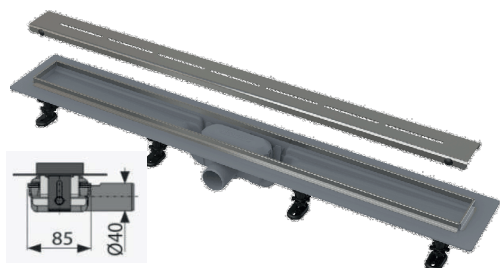

CÓDIGO	MEDIDA	€
24070913	550	155,00
24070914	650	166,00
24070915	750	178,00
24070916	850	192,00
24070917	950	204,00

## APZ19

CALEIRA PP PARA ENCASTRAR PAVIMENTO C/ GRELHA

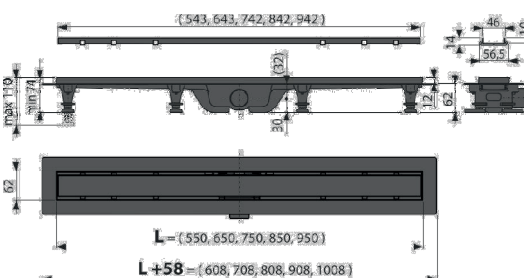

CÓDIGO	MEDIDA	€
24070823	550	105,00
24070824	650	115,00
24070825	750	124,00
24070826	850	137,00
24070827	950	149,00

» Grelha reversível inox à vista ou acabamento igual ao pavimento

## APZ19 BLACK

CALEIRA PP PARA ENCASTRAR PAVIMENTO C/ GRELHA

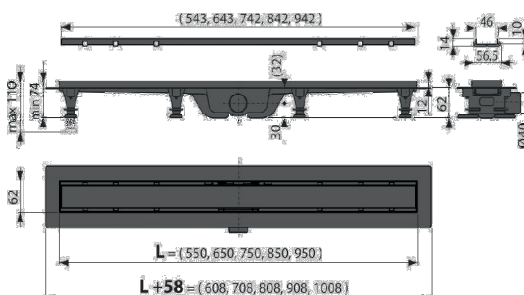

CÓDIGO	MEDIDA	€
24070833	550	121,00
24070834	650	134,00
24070835	750	143,00
24070836	850	159,00
24070837	950	172,00

» Grelha reversível inox à vista ou acabamento igual ao pavimento

# CALEIRA P/ DUCHE

## APZ-S6

SIFÃO EXTRA PLANO P/ CALEIRA INOX

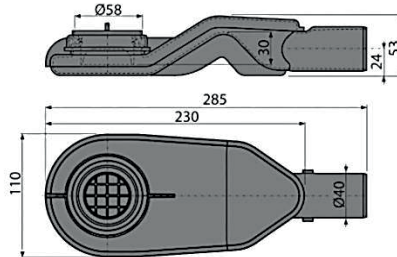

CÓDIGO	MEDIDA	€
24070961	40	35,00

- Altura Mínima 54mm
- Sifão para caleira inox APZ13

## APZ-S9

SIFÃO EXTRA PLANO P/ CALEIRA INOX

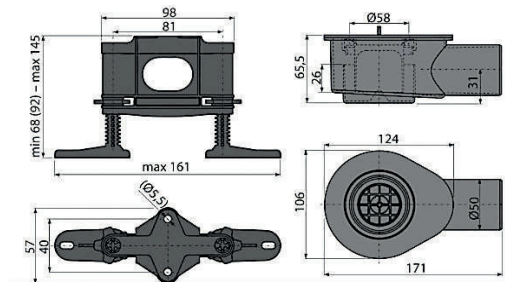

CÓDIGO	MEDIDA	€
24070962	50	35,00

- Altura Mínima 81mm
- Sifão para caleira inox APZ13

## APZ13 Double9

CALEIRA INOX P/ ENCASTRAR PAVIMENTO COM GRELHA

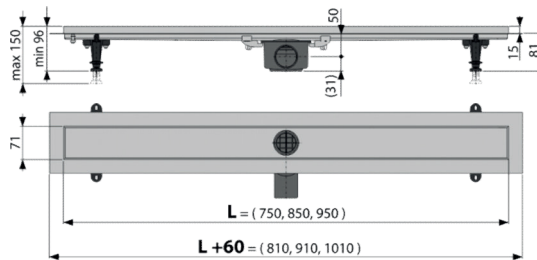

CÓDIGO	MEDIDA	€
24070973	550	242,00
24070974	650	257,00
24070975	750	273,00
24070976	850	292,00
24070977	950	310,00

- Grelha reversível inox à vista ou para acabamento igual pavimento

## ARZ1

CALEIRA INOX DE CANTO P/ DUCHE

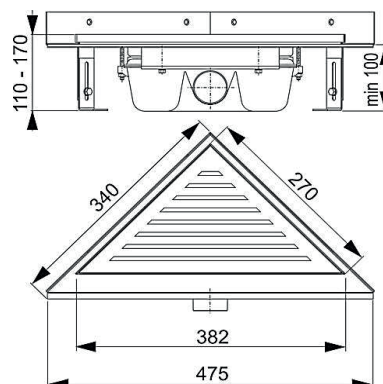
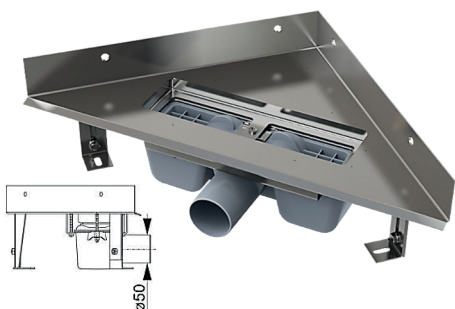

CÓDIGO	MEDIDA	€
24070972	340X340	372,00

# CALEIRA P/ DUCHE

## LIFE

GRELHA INOX P/ DUCHE

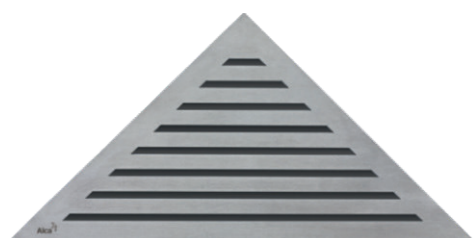

- Grelha para caleira ARZ1

CÓDIGO	MEDIDA	€
24071501	270X382	197,00

## VIEW

GRELHA INOX P/ DUCHE

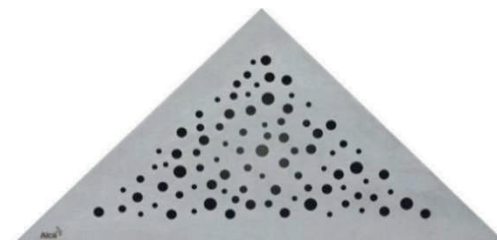

- Grelha para caleira ARZ1

CÓDIGO	MEDIDA	€
24071502	270X382	197,00

## APV140

SUMIDOURO EM INOX P/ DUCHE

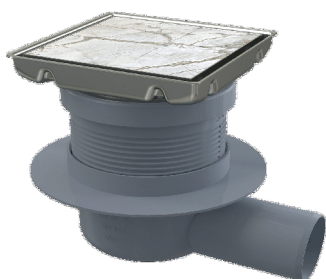

CÓDIGO	MEDIDA	€
	130x130	54,00

## APV240

SUMIDOURO EM INOX P/ DUCHE



CÓDIGO	MEDIDA	€
	130x130	54,00

## APV120

SUMIDOURO EM INOX P/ DUCHE



CÓDIGO	MEDIDA	€
24070982	130x130	165,00

## MPV013

GRELHA INOX P/ SUMIDOURO DUCHE

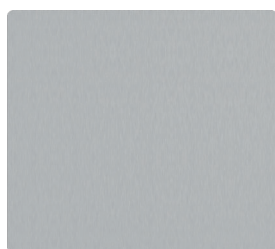

- Grelha para sumidouro APV120

CÓDIGO	MEDIDA	€
24071513	92x92	55,20

## MPV014

GRELHA INOX P/ SUMIDOURO DUCHE

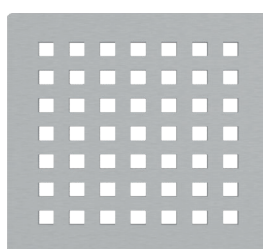

- Grelha para sumidouro APV120

CÓDIGO	MEDIDA	€
24071514	102x102	55,20

## MPV016

GRELHA INOX P/ SUMIDOURO DUCHE



- Grelha para sumidouro APV120

CÓDIGO	MEDIDA	€
24071516	92x92	58,70

## GRELHAS INOX P/ CALEIRAS DE DUCHE

### LINE

GRELHA INOX P/ CALEIRA DE DUCHE



- Grelha P/ caleiras modelos APZ101 / APZ104 / APZ12 / APZ22

### PURE

GRELHA INOX P/ CALEIRA DE DUCHE



- Grelha P/ caleiras modelos APZ101 / APZ104 / APZ12 / APZ22

### PURE BLACK

GRELHA INOX P/ CALEIRA DE DUCHE



- Grelha P/ caleiras modelos APZ101 / APZ104 / APZ12 / APZ22

### HOPE

GRELHA INOX P/ CALEIRA DE DUCHE



- Grelha P/ caleiras modelos APZ101 / APZ104 / APZ12 / APZ22

INOX MATE

MED. DUCHE	MED. GRELHA	CÓDIGO	€
600	550M	24071234	<b>67,00</b>
700	650M	24071235	<b>69,00</b>
800	750M	24071236	<b>73,00</b>
900	850M	24071237	<b>76,00</b>
1000	950M	24071238	<b>83,00</b>
1100	1050M	24071239	<b>86,00</b>
1200	1150M	24071240	<b>89,00</b>

INOX MATE

MED. DUCHE	MED. GRELHA	CÓDIGO	€
600	550M	24071214	<b>67,00</b>
700	650M	24071215	<b>69,00</b>
800	750M	24071216	<b>73,00</b>
900	850M	24071217	<b>76,00</b>
1000	950M	24071218	<b>83,00</b>
1100	1050M	24071219	<b>86,00</b>
1200	1150M	24071220	<b>89,00</b>

INOX MATE

MED. DUCHE	MED. GRELHA	CÓDIGO	€
600	550M	24071204	<b>69,00</b>
700	650M	24071205	<b>73,00</b>
800	750M	24071206	<b>79,00</b>
900	850M	24071207	<b>83,00</b>
1000	950M	24071208	<b>86,00</b>
1100	1050M	24071209	<b>89,00</b>
1200	1150M	24071210	<b>93,00</b>

INOX MATE

MED. DUCHE	MED. GRELHA	CÓDIGO	€
600	550M	24071224	<b>67,00</b>
700	650M	24071225	<b>69,00</b>
800	750M	24071226	<b>73,00</b>
900	850M	24071227	<b>76,00</b>
1000	950M	24071228	<b>83,00</b>
1100	1050M	24071229	<b>86,00</b>
1200	1150M	24071230	<b>89,00</b>

## GRELHAS INOX P/ CALEIRAS DE DUCHE

### BUBLE

GRELHA INOX P/ CALEIRA DE DUCHE



- Grelha P/ caleiras modelos APZ101 / APZ104 / APZ12 / APZ22

INOX MATE

MED. DUCHE	MED. GRELHA	CÓDIGO	€
600	550M	24071264	<b>67,00</b>
700	650M	24071265	<b>69,00</b>
800	750M	24071266	<b>73,00</b>
900	850M	24071267	<b>76,00</b>
1000	950M	24071268	<b>83,00</b>
1100	1050M	24071269	<b>86,00</b>
1200	1150M	24071260	<b>89,00</b>

### DREAM

GRELHA INOX P/ CALEIRA DE DUCHE



- Grelha P/ caleiras modelos APZ101 / APZ104 / APZ12 / APZ22

INOX MATE

MED. DUCHE	MED. GRELHA	CÓDIGO	€
600	550M	24071304	<b>67,00</b>
700	650M	24071305	<b>69,00</b>
800	750M	24071306	<b>73,00</b>
900	850M	24071307	<b>76,00</b>
1000	950M	24071308	<b>83,00</b>
1100	1050M	24071309	<b>86,00</b>
1200	1150M	24071310	<b>89,00</b>

### POSH

GRELHA INOX P/ CALEIRA DE DUCHE



- Grelha P/ caleiras modelo APZ106

INOX MATE

MED. DUCHE	MED. GRELHA	CÓDIGO	€
600	550MN	24071244	<b>203,00</b>
700	650MN	24071245	<b>216,00</b>
800	750MN	24071246	<b>232,00</b>
900	850MN	24071247	<b>245,00</b>
1000	950MN	24071248	<b>254,00</b>
1100	1050MN	24071249	<b>267,00</b>
1200	1150MN	24071250	<b>280,00</b>

### DESIGN

GRELHA INOX P/ CALEIRA DE DUCHE



- Grelha P/ caleiras modelos APZ106 / APZ116

INOX MATE

MED. DUCHE	MED. GRELHA	CÓDIGO	€
600	550MN	24071254	<b>79,00</b>
700	650MN	24071255	<b>83,00</b>
800	750MN	24071256	<b>86,00</b>
900	850MN	24071257	<b>92,00</b>
1000	950MN	24071258	<b>96,00</b>
1100	1050MN	24071259	<b>99,00</b>
1200	1150MN	24071260	<b>105,00</b>

## GRELHAS INOX P/ CALEIRAS DE DUCHE

### FLOOR

GRELHA INOX P/ CALEIRA DE DUCHE



• Grelha P/ caleiras modelos APZ106 / APZ116

INOX P/ COLOCAR MOSAICO

MED. DUCHE	MED. GRELHA	CÓDIGO	€
600	550	24071354	<b>115,00</b>
700	650	24071355	<b>121,00</b>
800	750	24071356	<b>127,00</b>
900	850	24071357	<b>134,00</b>
1000	950	24071358	<b>140,00</b>
1100	1050	24071359	<b>146,00</b>
1200	1115	24070729	<b>153,00</b>

### SOLID

GRELHA INOX P/ CALEIRA DE DUCHE



• Grelha P/caleiras modelos APZ12 / APZ22

INOX MATE

MED. DUCHE	MED. GRELHA	CÓDIGO	€
600	550	24071274	<b>89,00</b>
700	650	24071275	<b>102,00</b>
800	750	24071276	<b>112,00</b>
900	850	24071277	<b>121,00</b>
1000	950	24071278	<b>134,00</b>
1100	1050	24071279	<b>143,00</b>

### TILE

GRELHA INOX P/ CALEIRA DE DUCHE

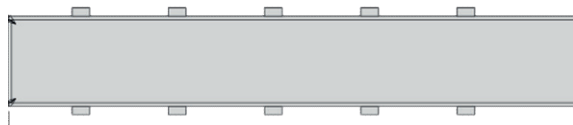

• Grelha P/caleiras modelos APZ12 / APZ22

INOX P/ COLOCAR MOSAICO

MED. DUCHE	MED. GRELHA	CÓDIGO	€
600	550	24071284	<b>115,00</b>
700	650	24071285	<b>121,00</b>
800	750	24071286	<b>127,00</b>
900	850	24071287	<b>134,00</b>
1000	950	24071288	<b>140,00</b>
1100	1050	24071289	<b>146,00</b>

### CODE

GRELHA INOX P/ CALEIRA DE DUCHE

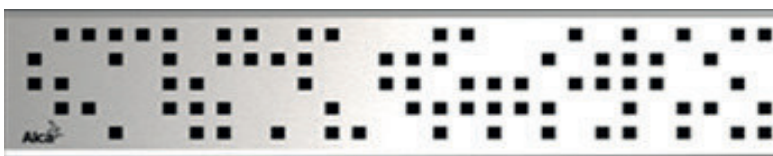

• Grelha P/ caleira modelo APZ13

INOX MATE

MED. DUCHE	MED. GRELHA	CÓDIGO	€
800	750M	24071406	<b>73,00</b>
900	850M	24071407	<b>76,00</b>
1000	950M	24071408	<b>83,00</b>

## GRELHAS INOX P/ CALEIRAS DE DUCHE

### ROUTE

GRELHA INOX P/ CALEIRA DE DUCHE



- Grelha P/ caleira modelo APZ13

INOX MATE			
MED. DUCHE	MED. GRELHA	CÓDIGO	€
800	750M	24071416	<b>73,00</b>
900	850M	24071417	<b>76,00</b>
1000	950M	24071418	<b>83,00</b>

### ZIP

GRELHA INOX P/ CALEIRA DE DUCHE



- Grelha P/ caleira modelo APZ13

INOX MATE			
MED. DUCHE	MED. GRELHA	CÓDIGO	€
800	750M	24071436	<b>73,00</b>
900	850M	24071437	<b>76,00</b>
1000	950M	24071438	<b>83,00</b>

### STREAM

GRELHA INOX P/ CALEIRA DE DUCHE



- Grelha P/ caleira modelo APZ13

INOX MATE			
MED. DUCHE	MED. GRELHA	CÓDIGO	€
800	750M	24071426	<b>162,00</b>
900	850M	24071427	<b>178,00</b>
1000	950M	24071428	<b>197,00</b>

### SPACE

GRELHA INOX P/ CALEIRA DE DUCHE



- Grelha P/ caleira modelo APZ13

INOX MATE			
MED. DUCHE	MED. GRELHA	CÓDIGO	€
800	750M	24071446	<b>86,00</b>
900	850M	24071447	<b>89,00</b>
1000	950M	24071448	<b>93,00</b>

# SUMIDOUROS P/ DUCHES

## APV1

SUMIDOURO C/ GRELHA INOX



CÓDIGO	MEDIDAS	€
24060302	105x105x50Ø	18,00

## APV2

SUMIDOURO C/ GRELHA INOX



CÓDIGO	MEDIDAS	€
24060301	105x105x50Ø	18,00

## APV26

SUMIDOURO C/ GRELHA INOX



CÓDIGO	MEDIDAS	€
24060341	105x105x50Ø	18,00

## APV31

SUMIDOURO C/ GRELHA INOX



CÓDIGO	MEDIDAS	€
24060330	105x105x50Ø	23,00

## APV31 BLACK

SUMIDOURO C/ GRELHA INOX



CÓDIGO	MEDIDAS	€
24060331	105x105x50Ø	45,00

## APV15

SUMIDOURO SAÍDA HORIZONTAL



CÓDIGO	MEDIDAS	€
24060319	150x150x50Ø	7,00

## APV16

SUMIDOURO SAÍDA VERTICAL



CÓDIGO	MEDIDAS	€
24060321	150x150x50Ø	7,00

## APV103

SUMIDOURO C/ ARO P/ TELA GRELHA INOX



CÓDIGO	MEDIDAS	€
24060512	105x105x50Ø	54,00

## APV203

SUMIDOURO C/ ARO P/ TELA GRELHA INOX



CÓDIGO	MEDIDAS	€
24060322	105x105x75Ø	54,00

# SUMIDOUROS P/ DUCHES

## APV3344

SUMIDOURO C/ GRELHA INOX

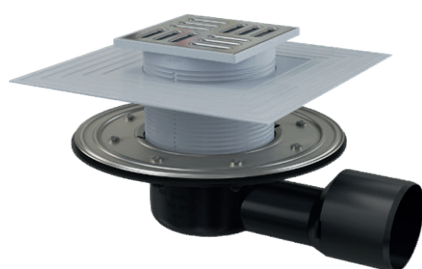

CÓDIGO	MEDIDAS	€
24060344	105x105x50Ø	45,00

## APV4344

SUMIDOURO C/ GRELHA INOX

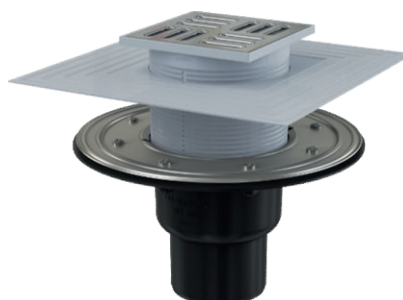

CÓDIGO	MEDIDAS	€
24060345	105x105x75Ø	45,00

## APV1324

SUMIDOURO C/ GRELHA LATÃO

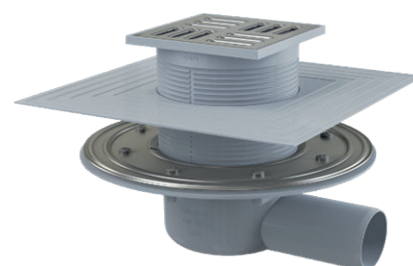

CÓDIGO	MEDIDAS	€
24060343	105x105x50Ø	45,00

## APV2324

SUMIDOURO C/ GRELHA LATÃO

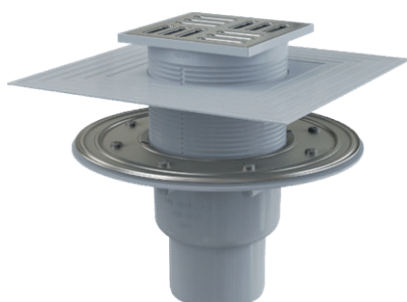

CÓDIGO	MEDIDAS	€
24060406	Ø 105x105x75	45,00

## APV12

SUMIDOURO C/ GRELHA INOX



CÓDIGO	MEDIDAS	€
24060312	Ø 150x150x100	26,00

## APV13

SUMIDOURO C/ ARO P/ TELA GRELHA INOX



CÓDIGO	MEDIDAS	€
24060313	Ø 150x150x110	26,00

## APV3513

SUMIDOURO PAVIMENTO VINIL GRELHA INOX



CÓDIGO	MEDIDAS	€
24060106	Ø 150	212,00

## AIZ1

TELA AUTOADESIVA

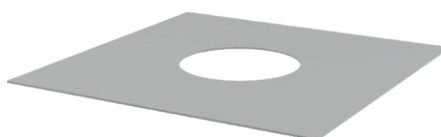

CÓDIGO	MEDIDAS	€
24060403	300x300	23,00

## AIZ3

MEMBRANA DE IMPERMEABILIZAÇÃO

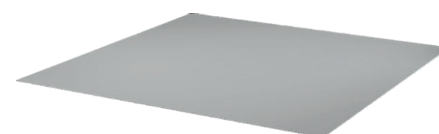

CÓDIGO	MEDIDAS	€
24060404	1300x1300	57,00

## AUTOCLISMOS INTERIORES C/ESTRUTURA P/SANITAS SUSPENSAS

### AM101B/1120



€

156,00

CÓDIGO  
24040218

- Revestimento anti-condensação
- Estrutura metálica resistente à corrosão
- Especial paredes ligeiras
- Espessura 125mm
- Descarga 3Lt. e 6 Lt.

### AM101/1120E

ecologico



€

156,00

CÓDIGO  
24040215

- Revestimento anti-condensação
- Estrutura metálica resistente à corrosão
- Especial paredes ligeiras
- Espessura 125mm
- Descarga 2Lt. e 4 Lt.

### AM101/850



€

215,00

CÓDIGO  
24040210

- Revestimento anti-condensação
- Estrutura metálica resistente à corrosão
- Especial paredes ligeiras
- Espessura 125mm
- Descarga 3Lt. e 6 Lt.

### AM1101B/1200 SLIM

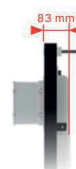

€

165,00

CÓDIGO  
24040217

- Revestimento anti-condensação
- Estrutura metálica resistente à corrosão
- Especial paredes ligeiras
- Espessura 83mm
- Descarga 3Lt. e 6 Lt.

### AM115/1000



€

153,00

CÓDIGO  
24040208

- Revestimento anti-condensação
- Estrutura metálica resistente à corrosão
- Especial paredes alvenaria
- Espessura 125mm
- Descarga 3Lt. e 6 Lt.

### AM1115/1000 SLIM



€

155,00

CÓDIGO  
24040205

- Revestimento anti-condensação
- Estrutura metálica resistente à corrosão
- Especial paredes alvenaria
- Espessura 86mm
- Descarga 3Lt. e 6 Lt.

## AUTOCLISMOS INTERIORES C/ESTRUTURA P/SANITAS SUSPENSAS

### AM1112B SLIM



€  
128,00

CÓDIGO  
24040155

- Revestimento anti-condensação
- Especial paredes alvenaria
- Espessura 84mm
- Descarga 3Lt. e 6 Lt.

### A93

AUTOCLISMO EXTERIOR



€  
33,00

CÓDIGO  
19090211

- Revestimento anti-condensação
- Dupla Descarga
- Autoc. Exterior insonorizado
- Especial paredes alvenaria

## ESTRUTURAS P/ BIDÉS E URINOIS SUSPENSOS

### A105/1200

ESTRUTURA P/ BIDE SUSPENSO



- Estrutura metálica resistente à corrosão
- Especial paredes ligeiras

CÓDIGO €  
24040104 150,00

### A105/450

ESTRUTURA P/ BIDE SUSPENSO



- Estrutura metálica resistente à corrosão
- Especial paredes ligeiras

CÓDIGO €  
24040102 197,00

### ST 035H

ESTRUTURA P/ BIDE SUSPENSO

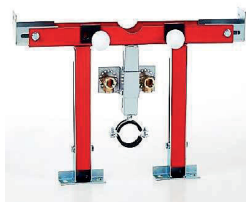

- Estrutura metálica resistente à corrosão
- Especial paredes ligeiras

CÓDIGO DETALHE €  
24040117 Sem Pateres 110,00

### ST 025GG

ESTRUTURA P/ BIDE SUSPENSO



- Estrutura metálica resistente à corrosão
- Especial paredes ligeiras

CÓDIGO DETALHE €  
24040111 Sem Pateres 96,00

### ST 030ZZ

ESTRUTURA P/ BIDE SUSPENSO



- Estrutura metálica resistente à corrosão
- Especial paredes ligeiras

CÓDIGO €  
24040112 78,00

### 83/B

ESTRUTURA P/ BIDE SUSPENSO



- Estrutura metálica zincada
- Especial paredes alvenaria

CÓDIGO €  
24040110 44,00

## ESTRUTURAS P/ BIDÉS, URINOIS E LAVATÓRIOS SUSPENSOS

### A107/1200 **alca**

ESTRUTURA P/ URINOL



- Estrutura metálica resistente à corrosão
- Especial paredes pladur

CÓDIGO	€
24040115	148,00

### A104/1200 **alca**

ESTRUTURA P/ LAVATORIO SUSPENSO



- Estrutura metálica resistente à corrosão
- Especial paredes pladur

CÓDIGO	€
24040251	128,00

# PLACAS DE DESCARGA



## FUN WHITE

PLACA DUPLA DESCARGA

BRANCA

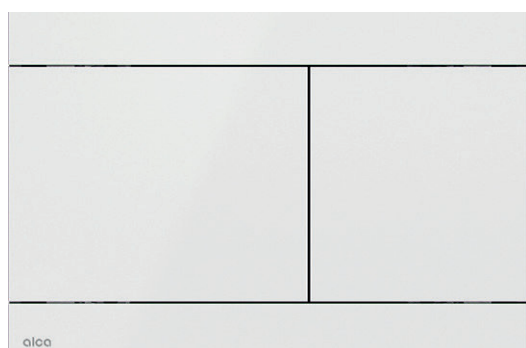

CÓDIGO	MEDIDAS	€
24040427	247x165	266,00

## FUN ANTIC

PLACA DUPLA DESCARGA

BRONZE

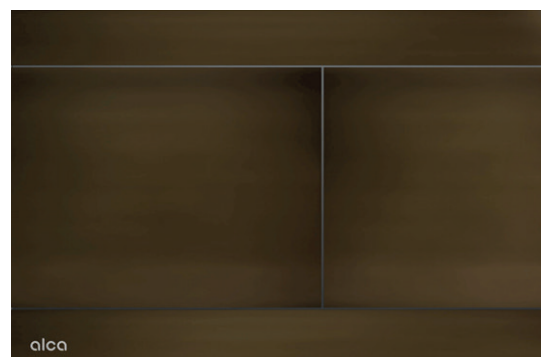

CÓDIGO	MEDIDAS	€
24040424	247x165	313,00

## FUN BLACK

PLACA DUPLA DESCARGA

PRETO

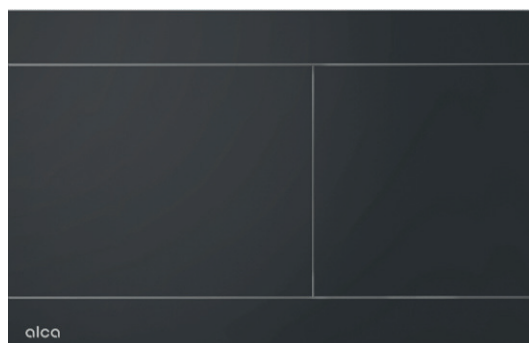

CÓDIGO	MEDIDAS	€
24040426	247x165	313,00

## FUN ALUNOX

PLACA DUPLA DESCARGA

INOX



CÓDIGO	MEDIDAS	€
24040421	247x165	195,00

## FUN-GM-B

PLACA DUPLA DESCARGA

GUN METAL ESCOV.



CÓDIGO	MEDIDAS	€
24040433	247x165	730,00

## FUN-GM-P

PLACA DUPLA DESCARGA

GUN METAL BRILHO

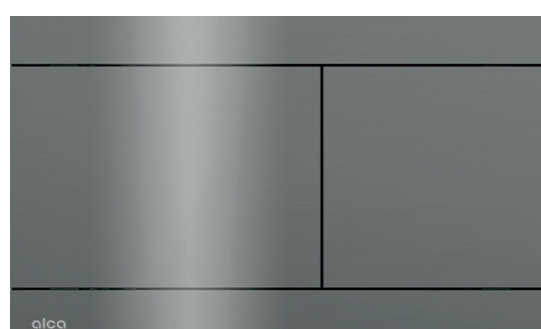

CÓDIGO	MEDIDAS	€
24040434	247x165	730,00

# PLACAS DE DESCARGA



## FUN-N-B

PLACA DUPLA DESCARGA

NICKEL ESCOV. MATE



CÓDIGO	MEDIDAS	€
24040435	247x165	730,00

## FUN-N-P

PLACA DUPLA DESCARGA

NICKEL BRILHO

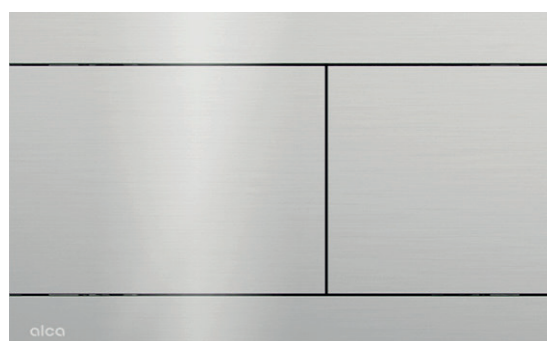

CÓDIGO	MEDIDAS	€
24040436	247x165	730,00

## FUN RG-B

PLACA DUPLA DESCARGA

OURO VERMELHO MATE



CÓDIGO	MEDIDAS	€
24040428	247x165	730,00

## FUN RG-P

PLACA DUPLA DESCARGA

OURO VERMELHO BRILHO

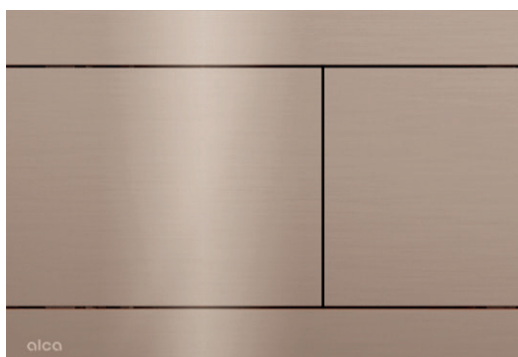

CÓDIGO	MEDIDAS	€
24040437	247x165	730,00

## FUN G-B

PLACA DUPLA DESCARGA

OURO ESCOV. MATE



CÓDIGO	MEDIDAS	€
24040429	247x165	730,00

## FUN G-P

PLACA DUPLA DESCARGA

OURO BRILHO

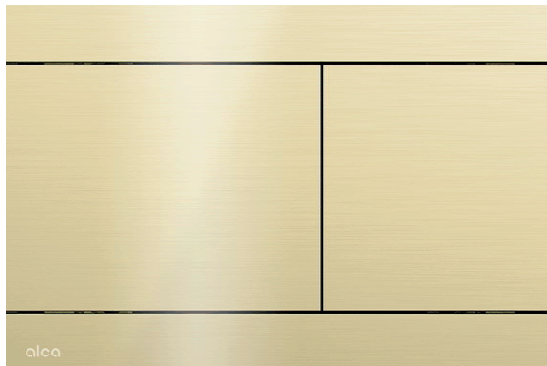

CÓDIGO	MEDIDAS	€
24040443	247x165	730,00

# PLACAS DE DESCARGA



## FUN BRASS

PLACA DUPLA DESCARGA

LATÃO

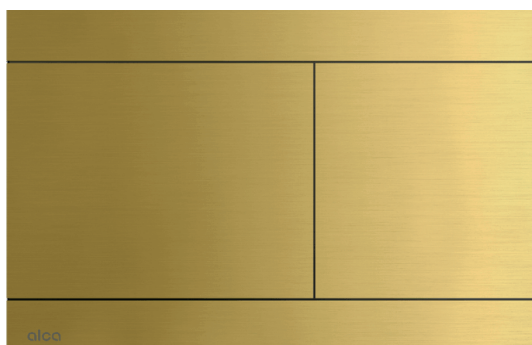

CÓDIGO	MEDIDAS	€
24040432	247x165	295,00

## MOON BRASS

PLACA DUPLA DESCARGA

LATÃO



CÓDIGO	MEDIDAS	€
24040453	247x165	295,00

## MOON BLACK

PLACA DUPLA DESCARGA

PRETA

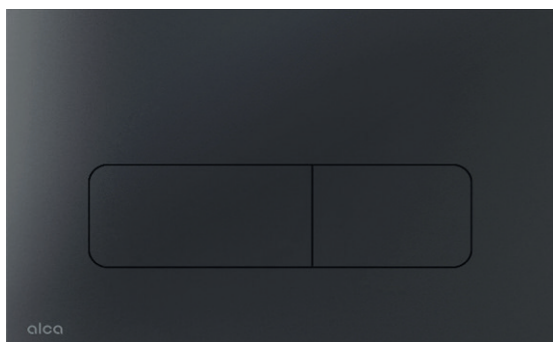

CÓDIGO	MEDIDAS	€
24040452	247x165	295,00

## MOON WHITE

PLACA DUPLA DESCARGA

BRANCA

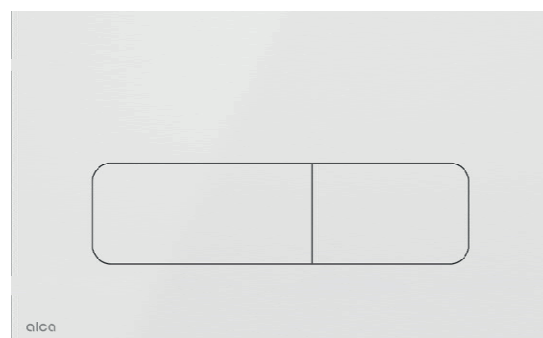

CÓDIGO	MEDIDAS	€
24040454	247x165	250,00

## MOON ALUNOX

PLACA DUPLA DESCARGA

INOX

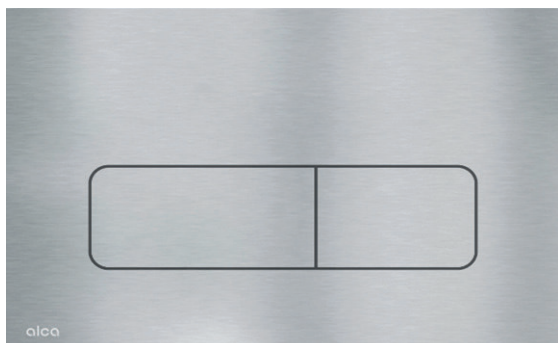

CÓDIGO	MEDIDAS	€
24040451	247x165	195,00

## STRIP ALUNOX

PLACA DUPLA DESCARGA

INOX



CÓDIGO	MEDIDAS	€
24040431	247x165	250,00

# PLACAS DE DESCARGA



## STRIP BLACK

PLACA DUPLA DESCARGA

PRETA



CÓDIGO	MEDIDAS	€
24040438	247x165	290,00

## TURN BLACK

PLACA DUPLA DESCARGA

PRETA



CÓDIGO	MEDIDAS	€
24040410	247x165	225,00

## TURN BRASS

PLACA DUPLA DESCARGA

LATÃO

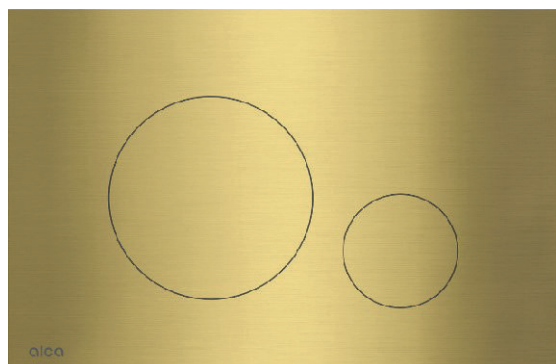

CÓDIGO	MEDIDAS	€
24040402	247x165	225,00

## TURN ALUNOX

PLACA DUPLA DESCARGA

INOX

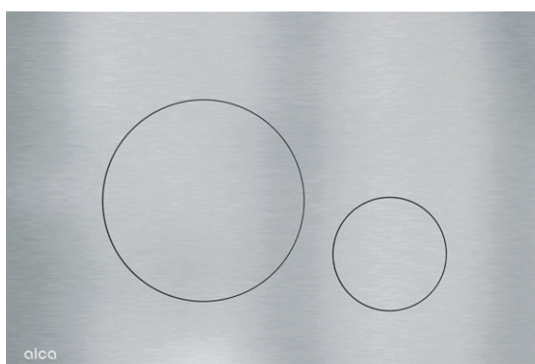

CÓDIGO	MEDIDAS	€
24040401	247x165	250,00

## RAY ALUNOX

PLACA DUPLA DESCARGA

ALUMINIO INOX



CÓDIGO	MEDIDAS	€
24040411	247x165	220,00

## RAY-GL1204

VIDRO PRETO



CÓDIGO	MEDIDAS	€
24040412	247x165	278,00

# PLACAS DE DESCARGA ABS

## M67X

PLACA DUPLA DESCARGA



CÓDIGO	COR	€
2404M670	BRANCO	48,60
2404M671	CROMO*	56,00
2404M672	MATE	60,00

## M675

PLACA DUPLA DESCARGA

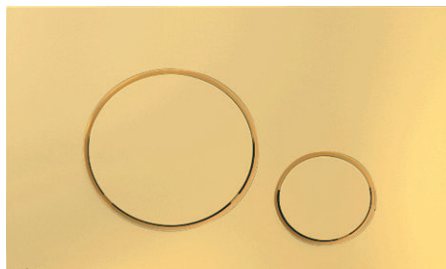

CÓDIGO	COR	€
2404M675	DOURADO	225,00

## M676

PLACA DUPLA DESCARGA

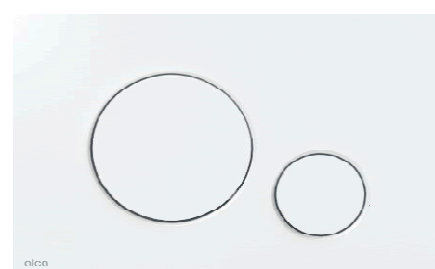

CÓDIGO	COR	€
2404M676	BRANCO MATE	62,50

## M678

PLACA DUPLA DESCARGA

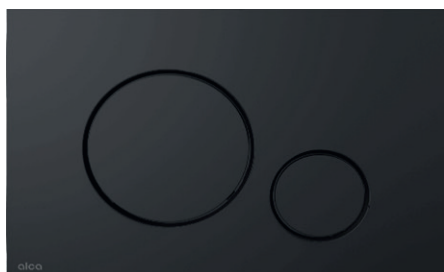

CÓDIGO	COR	€
2404M678	PRETO MATE	65,00

## M77X

PLACA DUPLA DESCARGA



CÓDIGO	COR	€
2404M770	BR./CROMO	48,00
2404M771	CROMO/MATE*	62,00
2404M772	MATE/CROMO	64,00
2404M776	BR./MATE	70,00

## M775

PLACA DUPLA DESCARGA



CÓDIGO	COR	€
2404M775	BR./OURO	65,00

## M778

PLACA DUPLA DESCARGA

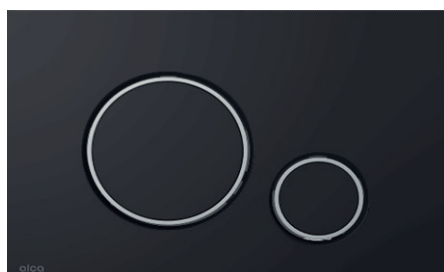

CÓDIGO	COR	€
2404M778	PRETO MATE/CROMO	70,00

## M778-5

PLACA DUPLA DESCARGA

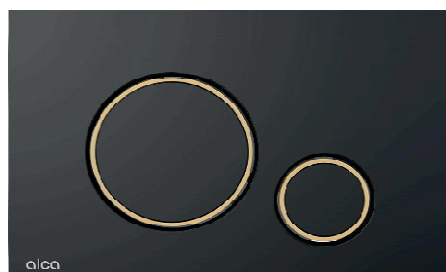

CÓDIGO	COR	€
240M7785	PRETO/DOURADO	78,50

## M57-G-M

PLACA DUPLA DESCARGA



CÓDIGO	COR	€
24M57GM	DOURADO MATE	70,00

# PLACAS DE DESCARGA ABS



## M57-GM-M

PLACA DUPLA DESCARGA



CÓDIGO	COR	€
24M57GMM	GUN METAL	70,00

## M57-NM

PLACA DUPLA DESCARGA



CÓDIGO	COR	€
240M57NM	NICKEL MATE	70,00

## M57-RG-M

PLACA DUPLA DESCARGA

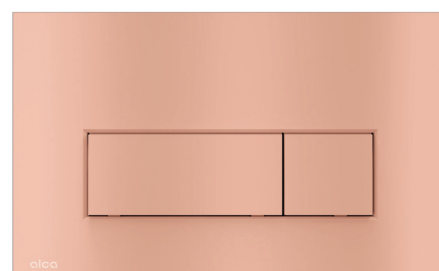

CÓDIGO	COR	€
24M57RGM	OURO VERM. MATE	70,00

## M57X

PLACA DUPLA DESCARGA



CÓDIGO	COR	€
2404M570	BRANCO	48,60
2404M571	CROMO*	56,00
2404M572	MATE	59,00
2404M576	BR. MATE	62,50

## M575

PLACA DUPLA DESCARGA



CÓDIGO	COR	€
2404M575	DOURADO	225,00

## M578

PLACA DUPLA DESCARGA



CÓDIGO	COR	€
2404M578	PRETO MATE	65,00

## M1721

PLACA DUPLA DESCARGA



CÓDIGO	COR	€
24041721	CROMO	50,00
24041722	MATE/CROMO*	62,50

## M1878-7

PLACA DUPLA DESCARGA



CÓDIGO	COR	€
24M18787	PRETO MATE/ OURO MATE	95,00

## M1878

PLACA DUPLA DESCARGA



CÓDIGO	COR	€
24M18780	PRETO MATE	72,00

# PLACAS DE DESCARGA ABS

## M1876-1

PLACA DUPLA DESCARGA



CÓDIGO	COR	€
24M18761	BRANCO MATE/ CROMO	66,00

## M1876

PLACA DUPLA DESCARGA



CÓDIGO	COR	€
24M18760	BRANCO MATE	63,00

## M1976

PLACA DUPLA DESCARGA

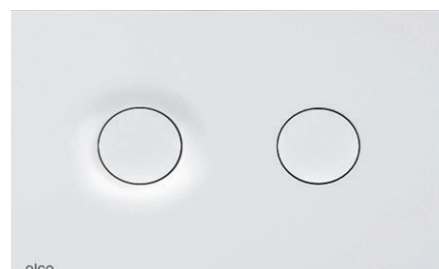

CÓDIGO	COR	€
24M19760	BRANCO MATE	63,00

## M1976-2

PLACA DUPLA DESCARGA

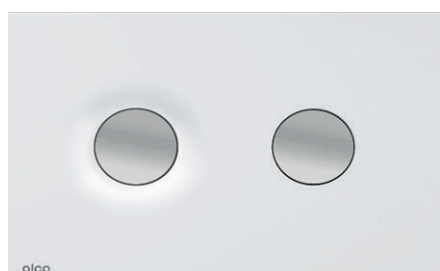

CÓDIGO	COR	€
24M19762	BR. MATE/ CROMO	66,00

## M1978

PLACA DUPLA DESCARGA



CÓDIGO	COR	€
24M19780	PRETO MATE	72,20

## M1978-7

PLACA DUPLA DESCARGA



CÓDIGO	COR	€
24M19767	PRETO MATE/ OURO MATE	95,00

## M279

PLACA DUPLA DESCARGA



CÓDIGO	COR	€
2404M279	METAL	155,00

## M270

PLACA DUPLA DESCARGA



CÓDIGO	COR	€
2404M270	BRANCO	32,00
2404M271	CROMO*	50,00
2404M272	MATE	48,90

## M70

PLACA DUPLA DESCARGA



CÓDIGO	COR	€
2404M070	BRANCO	32,80
2404M071	CROMO*	38,40

# MECANISMO P/ LOIÇAS SANITÁRIAS

## A08

MECANISMO DUPLA DESCARGA



- Dupla descarga 3 e 6 litros

CÓDIGO	U/C	€
24020201	16	21,00

## A05

MECANISMO INTERRUÇÃO DESCARGA



- Descarga Start/ Stop

CÓDIGO	U/C	€
24020207	25	19,60

## A2000

MECANISMO DESCARGA SIMPLS



- Descarga Start/ Stop

CÓDIGO	U/C	€
24020211	25	19,60

## BR006CB

MECANISMO DUPLA DESCARGA C/ CABO



CÓDIGO	U/C	€
24020203	25	21,50

## A08SK

KIT MACANISMO + TORNEIRA INFERIOR



- Mec. dupla descarga A08 + torneira inferior A18 3/8

CÓDIGO	U/C	€
24020331	20	31,00

## SA2000SK

KIT MACANISMO + TORNEIRA INFERIOR



- Mec. dupla desc. A2000 + torneira inferior A18

CÓDIGO	U/C	€
24020313	20	24,00

## A160 UNI

TORNEIRA BOIA LATERAL

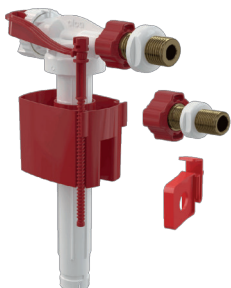

- Torneira de enchimento com casquilho latão de 1/2 e 3/8

CÓDIGO	MEDIDA	€
24020122	1/2 - 3/8	27,00

## A150 UNI

TORNEIRA BOIA LATERAL

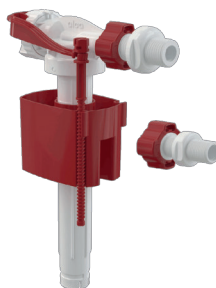

- Torneira de enchimento com casquilho plastico de 1/2 e 3/8

CÓDIGO	MEDIDA	€
24020112	1/2 - 3/8	13,50

## A15

TORNEIRA BOIA LATERAL



- Torneira boia entrada lateral rosca plastica

CÓDIGO	MEDIDA	€
24020108	3/8	8,10
24020105	1/2	8,10

# MECANISMO P/ LOIÇAS SANITÁRIAS

## A16

TORNEIRA BOIA LATERAL



- Torneira boia entrada lateral casquilho latão

CÓDIGO	MEDIDA	€
24020101	3/8	<b>13,20</b>
24020102	1/2	<b>13,20</b>

## A17

TORNEIRA BOIA INFERIOR TELESCÓPICA



- Torneira boia entrada lateral rosca plastica

CÓDIGO	MEDIDA	€
24020109	3/8	<b>11,00</b>
24020110	1/2	<b>11,00</b>

## A18

TORNEIRA BOIA INFERIOR TELESCÓPICA



- Torneira boia entrada lateral casquilho latão

CÓDIGO	MEDIDA	€
24020106	3/8	<b>15,20</b>
24020107	1/2	<b>15,20</b>

# VALVULAS - SIFÕES

## GRANDE

VALVULA LAVAT/BIDÉ CLIC CLAC



CÓDIGO	MATERIAL	€
16080401	LATÃO	14,30
16080404	ZAMAC	8,20

## PEQUENA

VALVULA LAVAT/BIDÉ CLIC CLAC



CÓDIGO	MATERIAL	€
16080301	LATÃO	11,00
16080304	ZAMAC	7,60

## GRANDE

VALVULA LAVAT/BIDÉ CURTA CLIC CLAC



CÓDIGO	COR	€
16080410	CROMADA	18,50

## PEQUENA

VALVULA LAVAT/BIDÉ CURTA CLIC CLAC



CÓDIGO	COR	€
16080310	CROMADA	18,00

## QUADRADA

VALVULA LAVAT/BIDÉ CLIC CLAC



CÓDIGO	COR	€
16080501	CROMADA	18,30

## GARRAFA

SIFÃO P/ VDA



CÓDIGO	COR	€
17010201	CROMADA	19,00

## CILINDRICO

SIFÃO P/ VDA

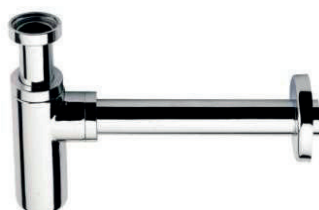

CÓDIGO	COR	€
17010301	CROMADA	28,50

## QUADRADO

SIFÃO P/ VDA



CÓDIGO	COR	€
17010501	CROMADA	66,50

## BIDÉ

SIFÃO P/ VDA



CÓDIGO	COR	€
17010401	CROMADA	37,20

## AUMENTO TELESCOPICO



CÓDIGO	COR	€
19040121	CROMADA	12,00

## TUBO ARTIC. PONTAS LISAS



CÓDIGO	COR	€
19040102	CROMADA	15,00

# SIFÕES P/ LAVATÓRIOS E URINÓIS

## A410

SIFÃO P/ LAVAT./ ESPELHO INOX



CÓDIGO	MEDIDA	€
24010121	11/4x70	6,10

## A420

SIFÃO P/ LAVAT./ ESPELHO ABS



CÓDIGO	MEDIDA	€
24010122	11/4	6,00

## A430

SIFÃO VDA P/ LAVATÓRIO



CÓDIGO	MEDIDA	€
24010102	11/4	4,50

## A45F DN32

SIFÃO CURVO VDA P/ LAVAT.



CÓDIGO	MEDIDA Ø	€
24010106	32mm	10,20

## A328CR

ADAPTADOR P/ LAVATÓRIO



CÓDIGO	MEDIDA	€
24010125	11/4	13,00

## A434

SIFÃO P/ LAVAT. ECON. ESPAÇO



CÓDIGO	MEDIDA	€
24010126	11/4	12,00

## A80 DN32

SIFÃO CURVO VDA P/ LAVAT.



CÓDIGO	MEDIDA	€
24010127	32mm	6,00

## A413

SIFÃO P/ LAVATÓRIO ECON. ESPAÇO



CÓDIGO	MEDIDA Ø	€
24010128	40mm	11,80

## A412 D40

SIFÃO P/ LAVAT. ECON. ESPAÇO



CÓDIGO	MEDIDA Ø	€
24010129	40mm	10,20

## SIFÕES P/ LAVATÓRIOS E URINÓIS

### A45A

SIFÃO P/ URINOL C/ EMBOQUE



CÓDIGO	MEDIDA	€
24010602	32	9,80

### A45C

SIFÃO P/ URINOL/ DESCARGA VERTICAL



CÓDIGO	MEDIDA	€
24010606	50x50	23,50

### A45B

SIFÃO P/ URINOL/ DESCARGA PAREDE



CÓDIGO	MEDIDA	€
24010605	50x40	23,00

## SIFÕES E VÁLVULAS P/ LAVA LOIÇAS

### A443

SIFÃO GARRAFA S/ VÁLVULA



CÓDIGO	MEDIDA	€
24010202	1 1/2x40-50	7,80

### A83

SIFÃO CURVO C/ TUBO EXTENS. P/ VALV.



CÓDIGO	MEDIDA	€
24010203	1 1/2x40-50	11,00

### A454P

SIFÃO DUPLO C/ CESTA



CÓDIGO	MEDIDA	€
24010209	1 1/2x40	43,70

### A456P

SIFÃO DUPLO C/ CESTA E RESPIRO



CÓDIGO	MEDIDA	€
24010229	1 1/2x115	62,90

### A448P

SIFÃO DUPLO S/ VÁLVULA



CÓDIGO	MEDIDA	€
24010225	1 1/2	12,20

### A447P

SIFÃO C/ CESTA E RESPIRO



CÓDIGO	MEDIDA	€
24010115	1 1/2x115	27,60

# SIFÕES E VÁLVULAS P/ LAVA LOIÇAS E MAQ. DE LAVAR

## A446P

SIFÃO C/ CESTA



CÓDIGO	MEDIDA	€
24010114	11/2x115	23,60

## A446

SIFÃO C/ CESTA



CÓDIGO	MEDIDA	€
24010206	11/2x40	23,00

## A33

VÁLVULA SIMPLES

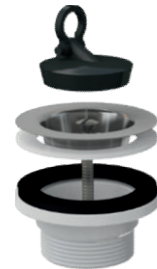

CÓDIGO	MEDIDA	€
24010231	11/2	3,20

## A331

VÁLVULA C/ RESPIRO



CÓDIGO	MEDIDA	€
24010232	11/2x115	8,50

## A37

VÁLVULA C/ CESTA



CÓDIGO	MEDIDA	€
24010235	11/2x115	16,90

## A38

VÁLVULA C/ CESTA E RESPIRO



CÓDIGO	MEDIDA	€
24010236	11/2x115	21,90

## APS3

SIFÃO MAQ. DE LAVAR/ ESPELHO INOX



CÓDIGO	MEDIDA	€
24010241	40	6,80

## APS4

SIFÃO MAQ. DE LAVAR/ ESPELHO ABS



CÓDIGO	MEDIDA	€
24010242	40	4,50

## APS6 - DUAS ENTRADAS

SIFÃO MAQ. DE LAVAR/ ESPELHO ABS



CÓDIGO	MEDIDA	€
24010246	40	41,00

# VALVULAS P/ LAVATÓRIO, BANHEIRA E BASE DE DUCHE

## A31

VÁLVULA LAVATÓRIO/BIDÉ



CÓDIGO	MEDIDAS	€
24010108	11/4x63	3,40

## VÁLVULA VERTICAL

VÁLVULA VERT. P/ BASE CHUV. RESINA



CÓDIGO	MEDIDAS	€
24010433	11/2x90	23,60

## R-60

VÁLVULA BASE CHUVEIRO PLANA



CÓDIGO	MEDIDAS	€
24010402	11/2x80	8,00

## R145

VÁLVULA BASE CHUVEIRO PLANA



CÓDIGO	MEDIDAS	€
24010408	11/2x115	18,00

## A47CR

VÁLVULA BASE CHUVEIRO FURO Ø 60



CÓDIGO	MEDIDAS	€
24010406	91x48/Ø40	16,90

## STANDARD

VÁLV. C/ARO INOX P/BASE CHUV. RESINA



CÓDIGO	MEDIDAS	€
24010424	90xØ40	12,50

## A491ESP

VÁLVULA BASE CHUVEIRO RESINA



CÓDIGO	MEDIDAS	€
24010413	90xØ40	15,50

## A491CR

VÁLVULA BASE CHUVEIRO FURO Ø 90



CÓDIGO	MEDIDAS	€
24010412	11/2x40	26,90

## SLIM aro inox

VÁLVULA BASE CHUVEIRO RESINA



CÓDIGO	MEDIDAS	€
24010431	90xØ40	16,00

## SLIM

VÁLVULA BASE CHUVEIRO FURO Ø 90



CÓDIGO	MEDIDAS	€
24010432	90xØ40	19,00

## A508CKM

VÁLVULA BANHEIRA C/ ENCHIMENTO



CÓDIGO	MEDIDAS	€
24010309	11/2x40	174,80

## A507KM

VÁLVULA BANHEIRA CLIC CLAC



CÓDIGO	MEDIDAS	€
24010312	11/2x40	53,80

## VALVULAS P/ BANHEIRA

### A51CRM

VÁLVULA BANHEIRA



CÓDIGO	MEDIDAS	€
24010304	11/2x40	37,70

### A508CKM

VÁLV. BANH. C/ ENCHIMENTO



CÓDIGO	MEDIDAS	€
24010307	11/2x40	16,90

### A507CKM

VÁLVULA BANHEIRA CLIC CLAC



CÓDIGO	MEDIDAS	€
24010306	11/2x40	18,00

### A501

VÁLVULA BANHEIRA SIFONICA



CÓDIGO	MEDIDAS	€
24010307	11/2x40	18,00

### A53

CURVA P/VALVULA BANHEIRA



CÓDIGO	MEDIDAS	€
24010568	11/2x40	3,90

### A53 DN40

CURVA P/VALVULA BANHEIRA



CÓDIGO	MEDIDAS	€
24010567	40	3,90

## CALÇÕES SANITA EXCÊNTRICOS E EXTENSÍVEIS

### A990

CALÇÃO SANITA EXCÊNTRICO



CÓDIGO	MEDIDAS	€
24030224	110x100	3,10

### A99

CALÇÃO SANITA RECTO



CÓDIGO	MEDIDAS	€
24030223	110x100	3,10

### A991-20

20mm  
CALÇÃO SANITA EXCÊNTRICO



CÓDIGO	MEDIDAS	€
24030207	110x100	6,00

### A991-40

40mm  
CALÇÃO SANITA EXCÊNTRICO



CÓDIGO	MEDIDAS	€
24030206	110x100	4,90

### A92

CALÇÃO SANITA EXCÊNTRICO PVC



CÓDIGO	MEDIDAS	€
24030212	110x110	13,50

### A91-250

CALÇÃO SANITA RECTO PVC



CÓDIGO	MEDIDAS	€
24010102	11/4	5,80

# CALÇÕES SANITA EXCÊNTRICOS E EXTENSÍVEIS

## A97SN

TUBO EXTENSÍVEL P/ SANITA

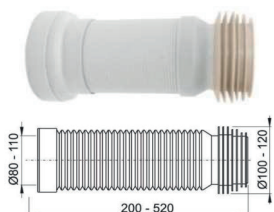

CÓDIGO	MEDIDAS	€
24030302	110x90	12,50

## A97

TUBO EXTENSÍVEL P/ SANITA



CÓDIGO	MEDIDAS	€
24030301	110x90	12,50

## M9006

TUBO EXTENSÍVEL P/ SANITA



CÓDIGO	MEDIDAS	€
24030303	110x90	26,90

## A97L

TUBO EXTENSÍVEL P/ SANITA



CÓDIGO	MEDIDAS	€
24030304	110x90	12,50

## A75

TUBO EXT. PORCA PLÁST. JUNTA PLANA

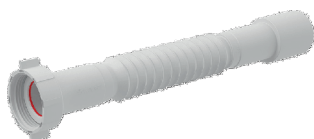

CÓDIGO	MEDIDAS	€
24010583	1 1/4x40-32	2,36
24010584	1 1/2x40-50	2,36

## A73

TUBO EXT. PORCA PLÁST. JUNTA PLANA

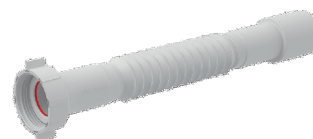

CÓDIGO	MEDIDAS	€
24010581	1 1/4x40-32	2,30

## A794

TUBO EXTENSIVEL PONTAS LISAS

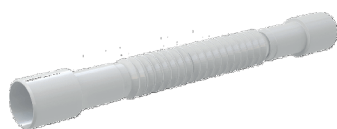

CÓDIGO	MEDIDAS	€
24010589	40-32x32-40	2,90

## A720

TUBO EXTENSIVEL PONTAS LISAS

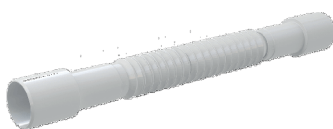

CÓDIGO	MEDIDAS	€
24010582	50-40x40-50	2,30

## SO556-ND

REDUÇÃO MACHO / FÊMEA



CÓDIGO	MEDIDAS	€
24050185	1 1/2x11/4	1,90

## SO507-ND

REDUÇÃO MACHO / FÊMEA



CÓDIGO	MEDIDAS	€
24050194	1 1/2x11/4	1,90

## A21

EMBELEZADOR P/LAVATORIO E BIDÉ



CÓDIGO	MEDIDAS	€
24050118	24 Ø	2,20

## A22

EMBELEZADOR P/LAVATORIO E BIDÉ



CÓDIGO	MEDIDAS	€
24050122	26 Ø	2,20



# SEPARADOR

8

- SECADORES DE MÃO
- DOSEADORES DE SABÃO
- DISPENSADORES DE PAPEL
- BARRAS DE APOIO
- TAMPOS DE SANITA



# SECADOR DE MÃOS

## 1100.S cyclon inox satinado

SECADOR DE MÃOS C/ PULSADOR



CÓDIGO €  
28100109 440,00

## 1101.S cyclon inox satinado

SECADOR DE MÃOS C/ SENSOR



CÓDIGO €  
28100111 428,00

## 1250.S inox satinado

SECADOR DE MÃOS C/ PULSADOR



CÓDIGO €  
28100135 275,00

## 1251.S inox satinado

SECADOR DE MÃOS C/ SENSOR



CÓDIGO €  
28100136 268,00

## 1451.S inox satinado

SECADOR DE MÃOS C/ SENSOR



CÓDIGO €  
28100138 295,00

## 1451.W inox branco

SECADOR DE MÃOS C/ SENSOR



CÓDIGO €  
28100137 237,00

## B335 inox escovado

SECADOR DE MÃOS C/ SENSOR



CÓDIGO €  
28100148 205,00

## B345B ABS branco

SECADOR DE MÃOS C/ SENSOR



CÓDIGO €  
28100105 257,00

## B391C ABS branco

SECADOR DE MÃOS AUTOMATICO



CÓDIGO €  
28100160 763,00

• Vertical

## 1303.W ABS branco

SECADOR DE MÃOS AUTOMATICO



• Vertical

CÓDIGO €  
28100153 1 355,00

# DOSEADORES DE SABÃO

## 3023.S inox satinado

DOSIFICADOR SABÃO AUTOMÁTICO



• Cap.: 1200ml

CÓDIGO	MEDIDAS	€
28100252	210x140x100	148,60

## 3001.S inox satinado

DOSIFICADOR SABÃO



• Cap.: 1200ml

CÓDIGO	MEDIDAS	€
28100216	210x121x130	35,00

## 3090 inox

DOSIFICADOR SABÃO



• Cap.: 1000ml

CÓDIGO	MEDIDAS	€
28100218	197x125x60	72,00

## 3095 inox escovado

DOSIFICADOR SABÃO



• Cap.: 500ml

CÓDIGO	MEDIDAS	€
28100217	150x95x60	31,00

## 3015.ABS branco

DOSIFICADOR SABÃO HOSPITALAR



• Cap.: 1000ml

CÓDIGO	MEDIDAS	€
28100225	295x235x100	52,00

## 3043.W branco

DOSIFICADOR SABÃO



• Cap.: 1000ml

CÓDIGO	MEDIDAS	€
28100215	209x129x98	25,00

## 3036.W ABS branco

DOSIFICADOR SABÃO



• Cap.: 1000ml

CÓDIGO	MEDIDAS	€
28100236	210x128x90	27,00

## 3036.N ABS preto

DOSIFICADOR SABÃO



• Cap.: 1000ml

CÓDIGO	MEDIDAS	€
28100237	210x128x90	46,00

## 3050.N inox preto

DOSIFICADOR SABÃO



• Cap.: 1200ml

CÓDIGO	MEDIDAS	€
28100238	200x125x95	131,00

## HS1000 ABS branco

DOSIFICADOR SABÃO/ GEL AUTOMÁTICO



• Cap.: 1000ml

CÓDIGO	MEDIDAS	€
28100221	150x115x155	36,00

# DISPENSADORES DE PAPEL

## 4005.S inox satinado

DISPENSADOR DE TOALHA ZIG ZAG



CÓDIGO	MEDIDAS	€
28100414	303x263x120	72,00

## 4006.S inox satinado

DISPENSADOR DE TOALHA ZIG ZAG



CÓDIGO	MEDIDAS	€
28100416	300x280x100	57,00

## 4006.N inox preto

DISPENSADOR DE TOALHA ZIG ZAG



CÓDIGO	MEDIDAS	€
28100417	300x280x100	88,60

## 4020.W ABS branco

DISPENSADOR DE TOALHA ZIG ZAG



CÓDIGO	MEDIDAS	€
28100419	370x276x128	33,00

## 4020.N ABS preto

DISPENSADOR DE TOALHA ZIG ZAG



CÓDIGO	MEDIDAS	€
28100421	370x276x128	55,00

## 4021.W ABS branco

DISPENSADOR DE TOALHA ZIG ZAG



CÓDIGO	€
28100422	32,00

## 4031.N ABS preto

DISPENSADOR DE TOALHA ZIG ZAG



CÓDIGO	MEDIDAS	€
28100417	330x290x105	97,00

## 4046.S inox satinado

DISPENSADOR DE TOALHA ZIG ZAG



CÓDIGO	MEDIDAS	€
28100413	300x255x105	95,00

# DISPENSADORES DE PAPEL HIGIÉNICO

## 5001.S inox satinado

DISPENSADOR PAPEL HIGIÉNICO



• Cap.: Rolo de 300 mt.

CÓDIGO	MEDIDAS	€
28100320	260x250x112	60,00

## 5004.N ABS preto

DISPENSADOR PAPEL HIGIÉNICO



• Cap.: Rolo de 300 mt.

CÓDIGO	MEDIDAS	€
28100321	274x252x125	54,30

## 5005.W ABS branco

DISPENSADOR PAPEL HIGIÉNICO



• Cap.: Rolo de 300 mt.

CÓDIGO	MEDIDAS	€
28100305	320x300x125	32,00

## 5005.N ABS preto

DISPENSADOR PAPEL HIGIÉNICO



• Cap.: Rolo de 280 mt.

CÓDIGO	MEDIDAS	€
28100306	320x300x125	57,00

## 8755

DISPENSADOR PAPEL HIGIÉNICO



• Cap.: Rolo de 300 mt.

CÓDIGO	MEDIDAS	€
28100307	280x260x120	31,00

## 5006.S inox satinado

DISPENSADOR PAPEL HIGIÉNICO



• Cap.: Rolo de 230 mt.

CÓDIGO	MEDIDAS	€
28100325	268x258x115	49,00

# BARRAS DE APOIO INOX

## 9001 mate

BARRA REBATÍVEL C/ PORTA ROLO

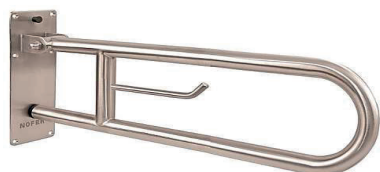

CÓDIGO	MEDIDA	DIAM. Ø	€
28090101	800	32mm	149,40

## 9001 mate

BARRA REBATÍVEL S/ PORTA ROLO



CÓDIGO	MEDIDA	DIAM. Ø	€
28090121	800	32mm	160,00

## 9001 mate

BARRA REBATÍVEL C/ PORTA ROLO



CÓDIGO	MEDIDA	DIAM. Ø	€
28090141	600	32mm	120,00

## 15064.S BARRA REBATÍVEL MATE

FIXAR AO CHÃO C/ PORTA ROLO



CÓDIGO	MEDIDA	€
28090131	818x750	348,00

## 9002 mate

BARRA ANGULO 135°



CÓDIGO	MEDIDA	€
24090201	400x400x70	93,00

## 9003 mate

BARRA RETA



CÓDIGO	MEDIDA	DIAM. Ø	€
28090303	300	32mm	43,00
28090304	450	32mm	46,00
28090306	600	32mm	54,30
28090308	800	32mm	63,00

## 15158

BARRA ANG. 90° C/ 3 PONTOS DE FIX. A PAREDE



CÓDIGO	MEDIDA	DIAM. Ø	€
28091001	700x400	32mm	131,00

## 9008 esquerda

BARRA FIXAÇÃO PAREDE/PAVIMENTO 3 PONTOS



CÓDIGO	MEDIDA	DIAM. Ø	€
28090801	700x700	32mm	200,00

# BARRAS DE APOIO INOX

## 9008 direita

BARRA FIXAÇÃO PAREDE/PAVIMENTO 3 PONTOS



CÓDIGO	MEDIDA	DIAM. Ø	€
28090850	700x700	32mm	200,00

## 9011 direita

BARRA PAREDE C/ APOIO



CÓDIGO	MEDIDA	DIAM. Ø	€
28091155	600	32mm	214,00

## 9011 esquerda

BARRA PAREDE C/ APOIO



CÓDIGO	MEDIDA	DIAM. Ø	€
28091105	600	32mm	214,00

## TN520

BANCO REBATÍVEL



CÓDIGO	MEDIDA	€
28090912	320x335	82,00

## 9009 satinado

BANCO REBATÍVEL C/ APOIO



CÓDIGO	MEDIDA	€
28090901	450x410	314,00

## HF10200

BANCO REBATÍVEL



CÓDIGO	MEDIDA	€
28090903	410x433	255,00

## HF10290

ESPELHO INCLINÁVEL



CÓDIGO	MEDIDA	€
28030202	580x730	285,00

## 9209

FRALDÁRIO HORIZONTAL



CÓDIGO	MEDIDA	€
28030301	880x500	500,00

# TAMPOS DE SANITA EM TERMODURO

## AQUARIUM/ MURANO

TAMPO SANITA TERMODURO

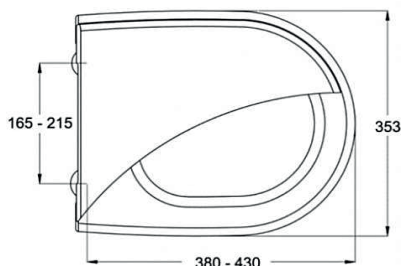

CÓDIGO	DOBRADIÇA	COR	€
15170201	NORMAL	BRANCO	<b>43,20</b>

## AVEIRO

TAMPO SANITA TERMODURO

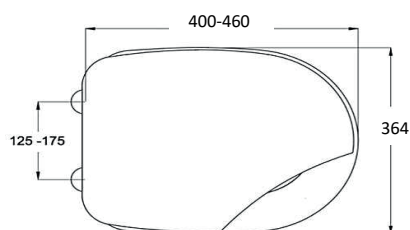

CÓDIGO	DOBRADIÇA	COR	€
19072191	NORMAL	BRANCO	<b>46,00</b>
19072192	NORMAL	PERGAMON	<b>55,50</b>
19072193	SOFT CLOSE	BRANCO	<b>78,00</b>
19072194	SOFT CLOSE	PERGAMON	<b>86,00</b>

## CITY

TAMPO SANITA TERMODURO

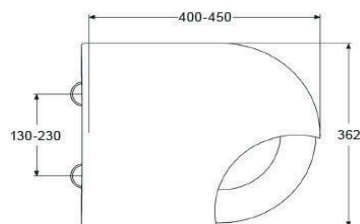

CÓDIGO	DOBRADIÇA	COR	€
19072246	NORMAL	BRANCO	<b>58,00</b>
19072247	SOFT CLOSE	BRANCO	<b>79,00</b>

## CONCORDE/ VENEZA

TAMPO SANITA TERMODURO

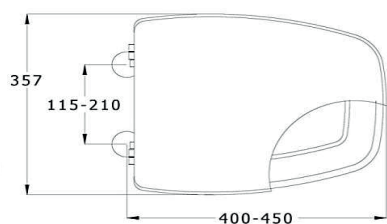

CÓDIGO	DOBRADIÇA	COR	€
19072271	NORMAL	BRANCO	<b>47,00</b>
19072272	NORMAL	AZUL SORRENTO	<b>55,00</b>
19072273	NORMAL	AZUL BERMUDA	<b>55,00</b>
19072274	NORMAL	BEGE BAHAMA	<b>55,00</b>
19072275	NORMAL	CINZENTO	<b>55,00</b>
19072276	NORMAL	PÉROLA	<b>55,00</b>
19072277	NORMAL	ROSA PÉROLA	<b>55,00</b>
19072278	NORMAL	ROSA SUNSET	<b>55,00</b>

# TAMPOS DE SANITA EM TERMODURO

## CONCORDE/ VENEZA

TAMPO SANITA TERMODURO

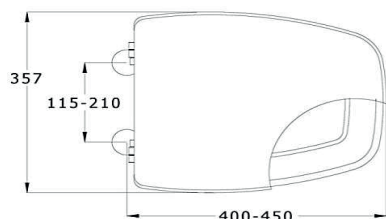

CÓDIGO	DOBRADIÇA	COR	€
19072281	SOFT CLOSE	BRANCO	81,00
19072282	SOFT CLOSE	AZUL SORRENTO	86,00
19072283	SOFT CLOSE	AZUL BERMUDA	86,00
19072284	SOFT CLOSE	BEGE BAHAMA	86,00
19072285	SOFT CLOSE	CINZENTO	86,00
19072286	SOFT CLOSE	PÉROLA	86,00
19072287	SOFT CLOSE	ROSA PÉROLA	86,00
19072288	SOFT CLOSE	ROSA SUNSET	86,00

## DURIUS

TAMPO SANITA TERMODURO

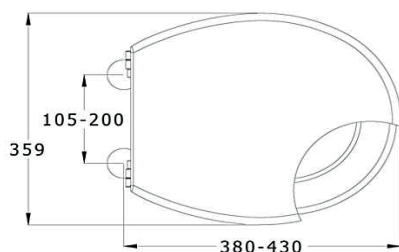

CÓDIGO	DOBRADIÇA	COR	€
19072291	NORMAL	BRANCO	46,20

## EDEN/ CALLA/ TESI

TAMPO SANITA TERMODURO

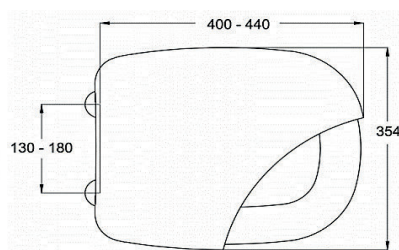

CÓDIGO	DOBRADIÇA	COR	€
19072161	NORMAL	BRANCO	42,00
19072162	SOFT CLOSE	BRANCO	77,00

## ESTORIL

TAMPO SANITA TERMODURO

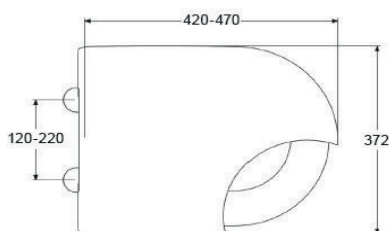

CÓDIGO	DOBRADIÇA	COR	€
19072101	NORMAL	BRANCO	46,00
19072102	NORMAL	PERGAMON	53,00
19072103	NORMAL	ALMOND	53,00
19072105	NORMAL	ROSA PÉROLA	53,00
19072111	SOFT CLOSE	BRANCO	76,60
19072112	SOFT CLOSE	PERGAMON	76,60
19072113	SOFT CLOSE	ALMOND	76,60
19072115	SOFT CLOSE	ROSA PEROLA	76,60

Compatível C/ Modelos: Alfa, Alfa Plus, Condor, Dama, Danubio, Florença, Renascença, Regina, Sirius, France

# TAMPOS DE SANITA EM TERMODURO

## EUROPA PLUS/ SPAIN

TAMPO SANITA TERMODURO

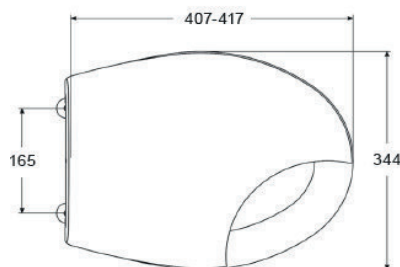

CÓDIGO	DOBRADIÇA	COR	€
19072131	NORMAL	BRANCO	<b>35,00</b>
19072132	NORMAL	PERGAMON	<b>43,00</b>

## EUROPA SUSPENSO

TAMPO SANITA TERMODURO

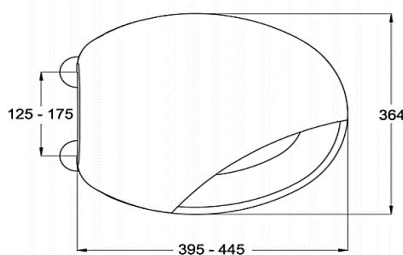

CÓDIGO	DOBRADIÇA	COR	€
19072201	NORMAL	BRANCO	<b>43,00</b>
19072202	NORMAL	PERGAMON	<b>50,00</b>
19072201	SOFT CLOSE	BRANCO	<b>74,00</b>

## IMAGE

TAMPO SANITA TERMODURO

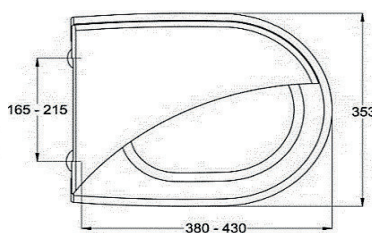

CÓDIGO	DOBRADIÇA	COR	€
19072121	NORMAL	BRANCO	<b>44,00</b>
19072122	NORMAL	PERGAMOND	<b>52,00</b>
19072123	NORMAL	ALMOND	<b>52,00</b>
19072124	NORMAL	CINZA	<b>52,00</b>
19072125	NORMAL	ROSA PÉROLA	<b>52,00</b>
19072222	SOFT CLOSE	BRANCO	<b>79,00</b>

Compatível C/ Modelos: Aqua, Eros, Rubi, Prestige, Proget

## PORTO BELLO

TAMPO SANITA TERMODURO

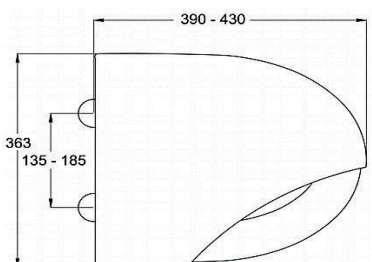

CÓDIGO	DOBRADIÇA	COR	€
19072236	NORMAL	BRANCO	<b>52,00</b>
19072237	NORMAL	PERGAMON	<b>59,00</b>
19072238	SOFT CLOSE	BRANCO	<b>95,00</b>

Compatível C/ Modelos: Jazz, Kapa, Metropol, Lara, Alexia, A1

# TAMPOS DE SANITA EM TERMODURO

## BREMEM/ STARCK/ BLOCK

TAMPO SANITA TERMODURO

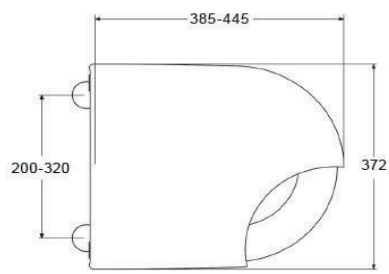

CÓDIGO	DOBRADIÇA	COR	€
19072216	SOFT CLOSE	BRANCO	<b>83,00</b>

## NAUTILUS

TAMPO SANITA TERMODURO

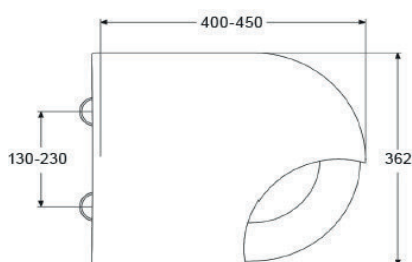

CÓDIGO	DOBRADIÇA	COR	€
19072211	NORMAL	BRANCO	<b>54,00</b>
19072212	NORMAL	PRETO	<b>56,00</b>
19072213	SOFT CLOSE	BRANCO	<b>79,00</b>
19072214	SOFT CLOSE	PRETO	<b>86,50</b>

## CONNECT/ CONCEPT

TAMPO SANITA TERMODURO

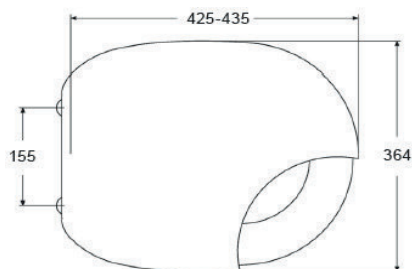

CÓDIGO	DOBRADIÇA	COR	€
19072225	NORMAL	BRANCO	<b>50,00</b>
19072224	SOFT CLOSE	BRANCO	<b>89,00</b>

## OPORTO/ DUNA

TAMPO SANITA TERMODURO

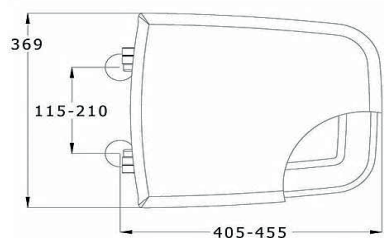

CÓDIGO	DOBRADIÇA	COR	€
19072296	NORMAL	BRANCO	<b>63,00</b>

# TAMPOS DE SANITA EM TERMODURO

## OPTIMA/ SANGRÁ

TAMPO SANITA TERMODURO

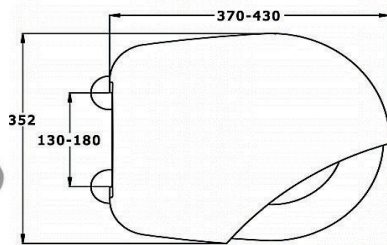

C�DIGO	DOBRADI�A	COR	�
19072256	NORMAL	BRANCO	<b>44,00</b>
19072257	SOFT CLOSE	BRANCO	<b>58,00</b>
19072258	NYLON	BRANCO	<b>33,00</b>

## OPUS/ VAL NCIA

TAMPO SANITA TERMODURO

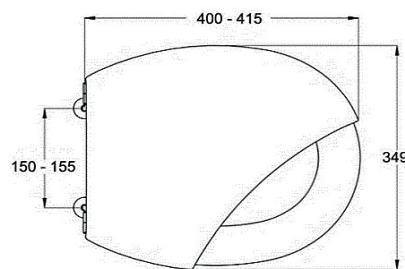

C�DIGO	DOBRADI�A	COR	�
19072216	NORMAL	BRANCO	<b>48,00</b>

## PORTO FINO/ NIZZA

TAMPO SANITA TERMODURO

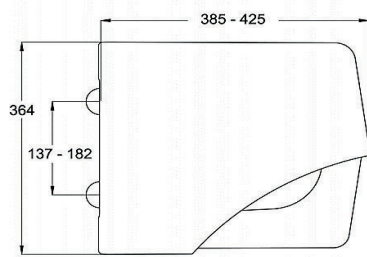

C�DIGO	DOBRADI�A	COR	�
19012231	NORMAL	BRANCO	<b>54,00</b>
19012232	SOFT CLOSE	BRANCO	<b>104,00</b>

## TAGUS/ M LAGA

TAMPO SANITA TERMODURO

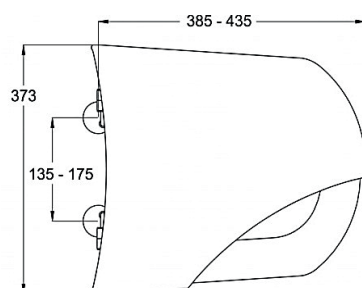

C�DIGO	DOBRADI�A	COR	�
19072176	NORMAL	BRANCO	<b>47,50</b>

# TAMPOS DE SANITA EM TERMODURO

## TECNO C1/ ALGER

TAMPO SANITA TERMODURO

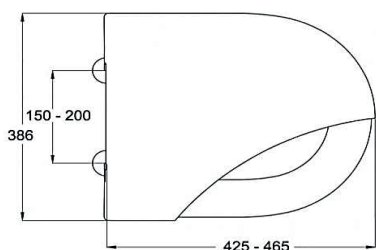

CÓDIGO	DOBRADIÇA	COR	€
19072166	NORMAL	BRANCO	<b>65,00</b>

## TECNO C2/ TUNIS

TAMPO SANITA TERMODURO

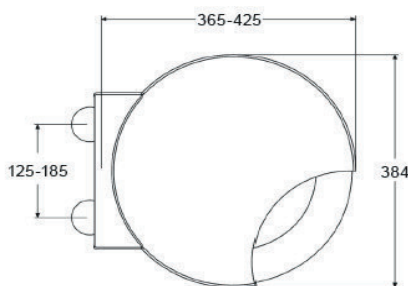

CÓDIGO	DOBRADIÇA	COR	€
19072196	NORMAL	BRANCO	<b>55,00</b>
19072197	SOFT CLOSE	BRANCO	<b>95,00</b>

## TECNO C4/ GRANADA

TAMPO SANITA TERMODURO

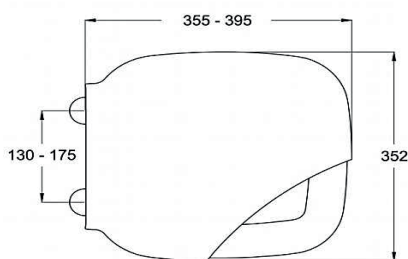

CÓDIGO	DOBRADIÇA	COR	€
19072171	NORMAL	BRANCO	<b>59,00</b>
19012177	SOFT CLOSE	BRANCO	<b>87,00</b>

## UNIVERSAL PLUS/ GERMANY

TAMPO SANITA TERMODURO

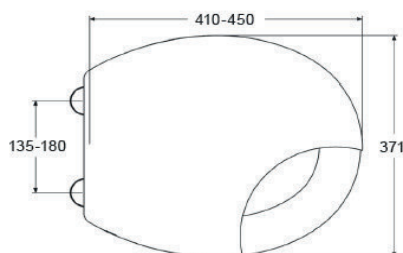

CÓDIGO	DOBRADIÇA	COR	€
19072206	NORMAL	BRANCO	<b>67,00</b>
19072207	NORMAL	PRETO	<b>75,00</b>

# TAMPOS DE SANITA EM TERMODURO

## NEXO/ STYLO/ MARSELLA

TAMPO SANITA TERMODURO

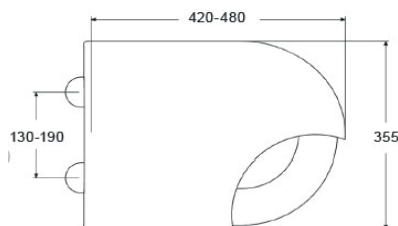

CÓDIGO	DOBRADIÇA	COR	€
19072261	NORMAL	BRANCO	<b>46,00</b>
19072266	SOFT CLOSE	BRANCO	<b>77,00</b>

## UNIVERSAL

TAMPO SANITA TERMODURO

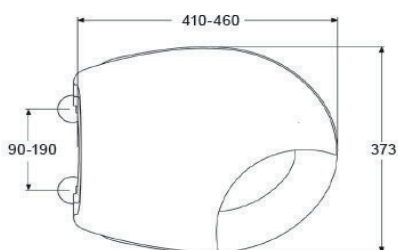

CÓDIGO	DOBRADIÇA	COR	€
19072141	NORMAL	BRANCO	<b>43,00</b>
19072142	NORMAL	PERGAMON	<b>51,00</b>
19072143	NORMAL	ALMOND	<b>51,00</b>
19072151	SOFT CLOSE	BRANCO	<b>78,50</b>
19072152	SOFT CLOSE	PERGAMON	<b>82,00</b>
19072153	SOFT CLOSE	ALMOND	<b>82,00</b>
19072155	SOFT CLOSE	ROSA PEROLA	<b>82,00</b>

**Compatível C/ Modelos:** Apolo, Cetus, Europa, Helia, Itália, Lisboa, M. Rosa, Madalena, Munique, Munique Plus, Lunar

## HOSPITALAR/ PROJECT RING/ CETUS

TAMPO SANITA TERMODURO

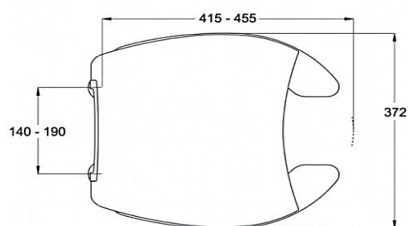

CÓDIGO	DOBRADIÇA	COR	€
19072221	NORMAL	BRANCO	<b>49,00</b>

MODELO	COR	CÓDIGO	€
DIANA SLIM	BRANCO	19070310	<b>40,00</b>
ATLANTIS SLIM	BRANCO	15035103	<b>40,00</b>
ASTER	BRANCO		<b>40,00</b>
LIFE	BRANCO	15025205	<b>40,00</b>
LIFE SLIM	BRANCO	15025207	<b>40,00</b>
LUNA	BRANCO	15025252	<b>40,00</b>
FEDORA	BRANCO	15013505	<b>40,00</b>
PLUMA	BRANCO	15013505	<b>40,00</b>
CHARME	BRANCO	15013276	<b>40,00</b>
CHARME SLIM	BRANCO	15013277	<b>40,00</b>
CATO	BRANCO	15075102	<b>40,00</b>
CATO SLIM	BRANCO	15075103	<b>40,00</b>
COZI	BRANCO		<b>40,00</b>
ASTRO	BRANCO		<b>40,00</b>
GLICINIA	BRANCO		<b>38,00</b>

MODELO	COR	CÓDIGO	€
COROA PP	BRANCO	15550102	<b>22,00</b>
IRIS	BRANCO	15351012	<b>40,00</b>
CATO SLIM	CINZA	15075110	<b>55,00</b>
CATO SLIM	PRETO	15075107	<b>55,00</b>
CATO SLIM	ANTRACITE	15075104	<b>55,00</b>
CATO SLIM	MOCA	15075109	<b>55,00</b>
CATO SLIM	VERDE		<b>55,00</b>
CATO SLIM	AZUL	15075108	<b>55,00</b>
IRIS	PRETO	15351015	<b>55,00</b>
IRIS	CINZA	15351013	<b>55,00</b>
IRIS	ANTRACITE	15351019	<b>55,00</b>
IRIS	MOCA	15351016	<b>55,00</b>
IRIS	VERDE	15351017	<b>55,00</b>
IRIS	AZUL	15351018	<b>55,00</b>
PALMA	PRETO MATE	15013227	<b>55,00</b>

# TAMPOS SANITA POLIPROPILENO

## EUROPA

TAMPO SANITA



CÓDIGO	DOBRADIÇA	COR	€
19070201	NORMAL	BRANCO	14,00

Compatível C/ Modelos: Europa, Monte Rosa

## UNIVERSAL

TAMPO SANITA



CÓDIGO	DOBRADIÇA	COR	€
19070101	NORMAL	BRANCO	14,00

Compatível C/ Modelos: Alfa, Image

## 15032

ASSENTO SANITA ERGON. S/TAMPA



Assento para pessoas de mobilidade reduzida adaptável em sanitas normais.

CÓDIGO	COR	€
19070925	BRANCO	80,00

## 15033

ASSENTO SANITA ERGON. C/TAMPA



Assento com tampa para pessoas de mobilidade reduzida adaptável em sanitas normais.

CÓDIGO	COR	€
19070926	BRANCO	97,00





# SEPARADOR

9

- SOALHO VINILICO
- PLACAS DECORATIVAS



## SOALHO VINILICO SPC



REF. 8002

CODIGO	€
35020812	35,00



REF. 8003

CODIGO	€
35020811	35,00

**NOTA:**

Os padrões apresentados nas imagens são aproximados do produto real

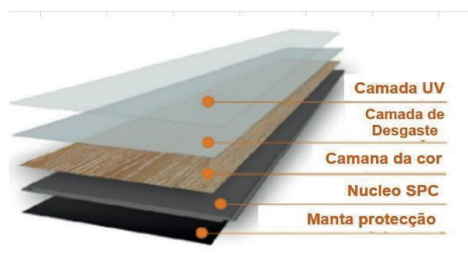

### INFORMAÇÃO

- MEDIDA DA PEÇA: 1220x183MM
- M<sup>2</sup> POR CAIXA: 1,78608
- PEÇAS POR CAIXA: 8
- CAIXAS POR PALETE: 50
- M<sup>2</sup> POR PALETE: 89,304



REF.8001

CODIGO	€
35020821	35,00

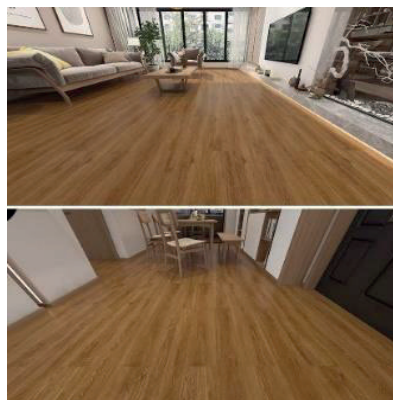

REF.9994

CODIGO	€
35020822	35,00

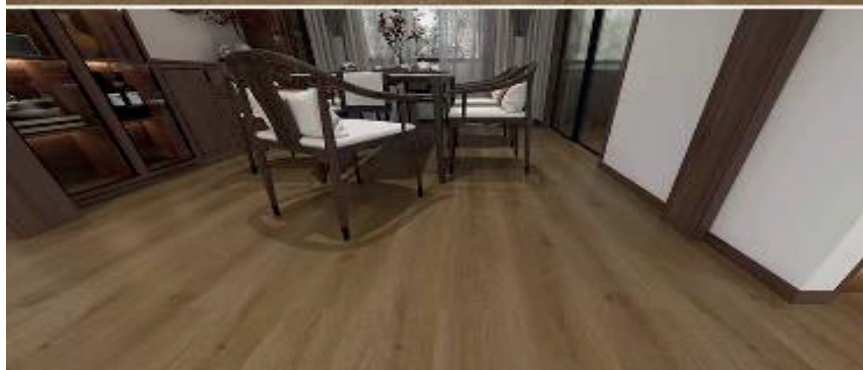

NOTA:

Os padrões apresentados nas imagens são aproximados do produto real

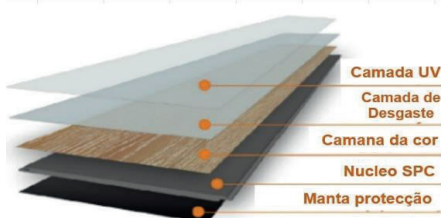

#### INFORMAÇÃO

- MEDIDA CADA PEÇA: 1220x183MM
- M<sup>2</sup> POR CAIXA: 1,78608
- PEÇAS POR CAIXA: 8
- CAIXAS POR PALETE: 50
- M<sup>2</sup> POR PALETE: 89,304

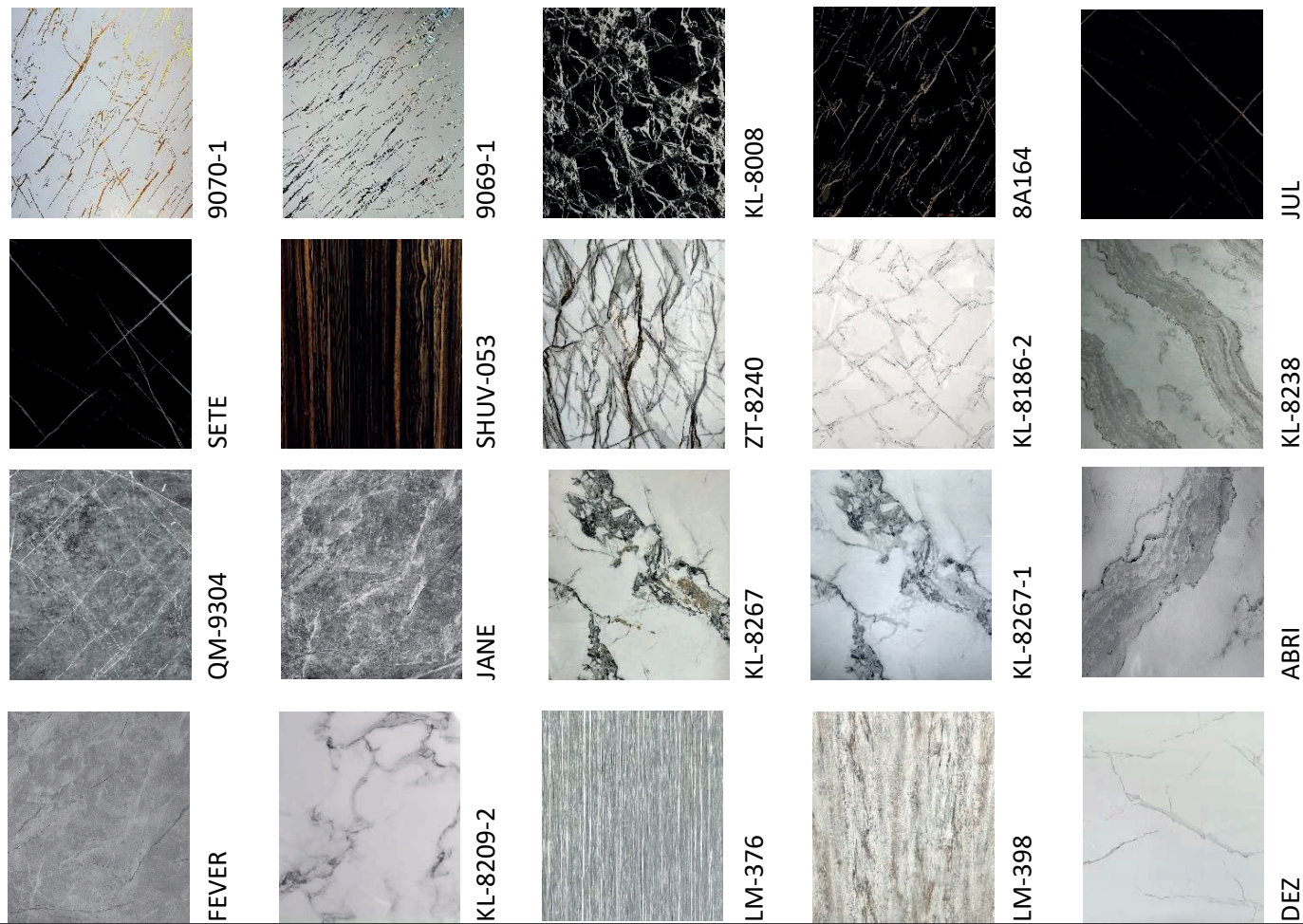

## Placas PVC / Acrilico - Revestimento Paredes



Preço: 29,90€/m<sup>2</sup>

Medidas: 2,44x1,22m



KL-8022



HF-1533



LNUV-046



QM-9040



LUV-052



LW-562



LNUV-029



SHUV-100

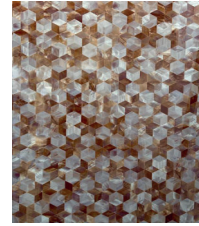

SHUV-101



CREME

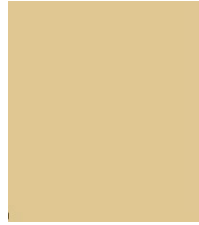

BEJE



GOLD



CINZENTA



PRETA



BRANCA



NA COLOCAÇÃO NÃO UTILIZAR COLA E VEDA COM ÁCIDO ACÉTICO OU SOLVENTE



Painel vinílico  
Vinyl panel, panel de vinilo



Corte e Aplicação Fácil  
easy cut and application/fácil  
corte y aplicación



Limpeza Fácil  
easy cleaning/fácil limpieza



Resistente a arranhões  
scratch resistant/resistente a  
los arañazos



Aumento da estabilidade  
increased stability/mayor  
estabilidad



Espessura  
Thickness/grosor

Preço: 29,90€/m<sup>2</sup>

Medidas: 2,44x1,22m